



# **RFG REQUIREMENTS OF GENERAL APPLICATION**

Following Art. 7(4) of the NC RFG

22 August 2019 – Submitted for approval

---

---

# Contents

<b>1</b>	<b>Introduction .....</b>	<b>4</b>
<b>2</b>	<b>Determination of significance [Art 5] .....</b>	<b>6</b>
2.1	Conditions for the choice of the maximum capacity thresholds .....	7
2.1.1	Voltage withstand Capabilities for PGM connected to TSO .....	7
2.1.2	Other conditions .....	8
<b>3</b>	<b>Type A Requirements .....</b>	<b>9</b>
3.1	Frequency Requirements .....	9
3.1.1	Frequency withstand capability [Art. 13-1 (a)] .....	9
3.1.2	Rate Of Change Of Frequency (ROCOF) withstand capability [Art 13.1(b)] .....	9
3.1.3	Loss Of Main (LOM) Protection triggered by rate-of-change-of-frequency-type [Art 13.1(b)] .....	10
3.1.4	Limited Frequency Sensitive Mode – Over frequency (LFSM-O) [Art. 13-2 (a-g)] .....	10
3.1.5	Admissible maximum power reduction with falling frequency [Art. 13-4 and 5] .....	12
3.1.6	Logical interface to cease active power injection [Art 13-6].....	13
3.1.7	Automatic connection [Art 13-7] .....	13
<b>4</b>	<b>Type B Requirements .....</b>	<b>15</b>
4.1	Frequency stability and active power management .....	15
4.1.1	Remote control reduction of active power [Art 14 -2].....	15
4.1.2	Automatic reconnection [Art 14-4 (a-b)] .....	15
4.2	Instrumentation [Art 14-5] .....	15
4.2.1	Structural data: control and electrical protection schemes and settings [Art 14-5 (a + b)].....	15
4.2.2	Information exchanges [Art 14-5(d)] .....	16
4.3	Type B – SPGM Requirements .....	17
4.3.1	Reactive power capabilities - SPGM [Art 17-2(a)] .....	17
4.3.2	Voltage Control SPGM type B [Art 17-2 (b)].....	18
4.3.3	Fault-ride through for symmetrical and asymmetrical faults for SPGM [Art 14-3].....	18
4.3.4	Post-fault active power recovery - SPGM [Art 17-3] .....	19
4.4	Type B – PPM Requirements.....	19
4.4.1	Fault-ride through for symmetrical and asymmetrical faults - PPM [Art 14.3] .....	19
4.4.2	Reactive capabilities - PPM [Art 20-2(a)] .....	20
4.4.3	Fault Current & dynamic voltage support [Art 20-2 (b and c)]....	21
4.4.4	Post-fault active power recovery [Art 20-3] .....	22
<b>5</b>	<b>Type C Requirements.....</b>	<b>23</b>
5.1	Frequency stability & Active Power management .....	23
5.1.1	Active Power Controllability and Control Range [Art. 15-2 (a-b)]	23
5.1.2	Limited frequency sensitive mode – under frequency (LFSM-U) [Art. 15-2 (c)] .....	23
5.1.3	Frequency Sensitive Mode [Art. 15.2.d].....	24
5.1.4	Frequency restoration control [Art 15-2(e)] .....	25
5.1.5	Real-time monitoring of FSM [Art 15-2(g)] .....	25
5.1.6	Automatic disconnection for voltage outside ranges [Art 15-3] ...	25
5.1.7	Rates of change of active power output [Art 15-6(e)] .....	26
5.2	System restoration [Art 15-5] .....	26
5.2.1	Capability to take part in island operation [Art 15.5(b)].....	26
5.2.2	Quick resynchronization capability [Art 15-5(c)].....	26
5.3	Instrumentation, simulation and protection.....	26
5.3.1	Loss of angular stability or loss of control [Art 15.6(a)] .....	26
5.3.2	Instrumentation [Art 15.6(b)] .....	27
5.3.3	Simulation models [Art 15.6(c)] .....	27
5.3.4	Devices for system operation and security [Art 15.6(d)].....	27
5.3.5	Earthing of the neutral point at the network side of the step-up transformer [Art 15.6(f)] .....	27

---

5.4	Voltage control mode (for SPGM and PPM) [Art 19-2(a) and Art 21-3(d)]	27
5.5	Type C SPGM Requirements	28
5.5.1	Reactive power capability SPGMs [Art 18-2]	28
5.5.2	Voltage control requirements for SPGM type C	29
5.6	Type C PPM Requirements	29
5.6.1	Synthetic inertia for PPM [Art 21-2]	29
5.6.2	Reactive capabilities - PPM [Art 21-3(a-c)]	29
5.6.3	Voltage control - PPM [Art 21-3 (d) and (e)]	31
<b>6</b>	<b>Type D Requirements</b>	<b>32</b>
6.1	Voltage Control	32
6.1.1	Voltage withstand capability [Art 16-2(a & b)]	32
6.1.2	Automatic disconnection for voltage outside ranges [Art 16-2(c)]	32
6.2	Resynchronization [Art 16-4]	32
6.3	Type D SPGM Requirements	33
6.3.1	Fault-ride through for symmetrical and asymmetrical faults – SPGM [Art 16-3]	33
6.3.2	Voltage stability SPGM [Art 19-2]	34
6.3.3	Technical capabilities to support angular stability under fault conditions for SPGM [Art 19-3]	34
6.4	Type D – PPM	34
6.4.1	Fault-ride through for symmetrical and asymmetrical faults – PPM [Art. 16-3]	34
<b>7</b>	<b>Acronyms</b>	<b>36</b>
<b>8</b>	<b>References</b>	<b>36</b>
<b>9</b>	<b>Appendix I – Definition FRT profile (extract from Art. 14.3 RfG[1])</b>	<b>37</b>

---

# 1 Introduction

Article 7(4) of the NC RfG [1] states that the relevant system operator or TSO submits a proposal for requirements of general application (or the methodology used to calculate or establish them), for approval by the competent entity, within two years of entry into force of the NC RfG, i.e. 17 May 2018. A similar requirement is included in the two other connection Network Codes, namely in Art. 6(4) of the NC DCC [2] and in Art. 5(4) of the NC HVDC [3].

The aim of this document is to synthesize the technical proposal regarding the Belgian implementation of the non-exhaustive requirements stated in the NC RfG. This document is the final version of the proposal for requirements of general application (hereafter named as ‘general requirements’), in accordance with Art. 7(4) of the NC RfG.

The proposal is mainly focusing on requirements set by Elia, as (relevant) TSO or relevant system operator.

The implementation of the non-exhaustive requirements of the public DSO is proposed in the Synergrid C10-11 technical specifications. Requirements that are defined by Elia as TSO, for generation connected to public DSOs, are covered in the C10-11 and expected to be in line with the relevant prescriptions of the actual document.

To facilitate the implementation of the NC RfG requirements, Elia and the public DSOs aligned as much as possible to increase the coherency and avoid as much as possible discrimination between a transmission-, or distribution-connected Power Generating Module (PGM) in terms of technical requirements and legal readability.

On 17 May 2018, Elia has submitted the proposals for general requirements for NC RfG, but also for NC DCC and NC HVDC to the competent authorities together with the (track change) proposal of the amended Federal Grid Code [4] and the formal proposal on maximum capacity thresholds of type B, C and D PGM. Elia has organized beforehand a public consultation for all deliverables from 15 March up to and including 16 April 2018 for the Federal Grid Code and up to and including 23 April 2018 for the general requirements. The public consultation on the maximum capacity thresholds B, C and D already took place from 19 May till 20 June 2017. This approach is in line with the vision of the Belgian Federal Administration (FOD/SPF Energy) [5].

This document represents the final position of Elia after discussions with the stakeholders in each of the relevant topics. During the last months, this document was gradually completed and presented to stakeholders, especially during the Federal Grid Code workshops, until all non-exhaustive general requirements were included.

The document follows the same article order as in the NC RfG: the proposal is organized per technical topic and per PGM category, assuming the thresholds B, C and D as defined in Elia’s (and public DSOs’) proposal. If not otherwise specified, each higher category has to fulfil the requirement of the lower one. As an example, the LFSM-O is specified for type A, but it is also valid for types B, C and/or D PGMs.

The scope of this document contains especially, but is not limited to, the implementation proposal of the non-exhaustive requirements in the NC RfG. To increase its readability, this document might also contain NC exhaustive requirements, implementation proposals of non-exhaustive requirements of the other connection NC, or other specific national/regional requirements for information purposes only, but certainly does not cover all of them.

With respect to the complete list of non-exhaustive requirements to be proposed as general requirements, Elia is taking as reference the ENTSO-E implementation guidance document (IGD) on ‘Parameter of Non-exhaustive requirements’ [6] to be defined by the (relevant) TSO and the relevant system operator. This document does not only mention the parameters to be defined per topic, but also which article of each connection NC should be considered as non-exhaustive and who should be the relevant system operator to define an implementation proposal.

As a general consideration, the present document proposes minimum requirements. If a PGM has capabilities beyond the minimum requirements and its utilization has no negative technical impacts on its normal operation, these capabilities should be available for activation in agreement with the relevant system operator (this will be defined during connection agreement). As a matter of example, should the

---

PGM have capabilities beyond the minimum Fault Ride Through profile (cf. Art. 14-3), the PGM is expected not to limit its capabilities to comply with the minimum requirement but to use the full capability to support the system stability as stated in its agreement. The actually implemented PGM characteristics and functionalities must be communicated to the relevant system operator and/or transmission system operator.

The TSO can grant exceptions for a specific connection point, if the technical or economic advantages of the exception are demonstrated. Therefore, the grid user connected to the Elia Network must address a motivated request to the TSO, which analyzes the reasons cited. In case the TSO considers that the reasons given for the exception do not contain sufficient evidence, are not justified, are not linked to technical or economic reasons or are contrary to the regulation, it will provide a motivated justification to the grid user. In accordance with the applicable regulation, the grid user may appeal the TSO's decision to the competent regulatory authority.

In line with NC RfG article 3.2(b) the general requirements are not applicable to backup-power PGM<sup>1</sup>, unless these PGM are offering ancillary services on a voluntary basis for more than 5 minutes a month.

In this document, the Elia Network is defined as the electricity network on which Elia holds ownership rights or at least a utilization or operation right, and for which Elia is designated as system operator. Despite the fact that Elia also operates the transmission network at voltage levels above 70kV, this term, for the purposes of this document, also includes the local transmission networks, and the regional transmission network and "Plaatselijk Vervoernet" all at 70kV and lower for which Elia is designated as system operator.

---

<sup>1</sup> Power-generating modules that were installed to provide back-up power and operate in parallel with the system for less than five minutes per calendar month while the system is in normal system state. Parallel operation during maintenance or commissioning tests of that power-generating module shall not count towards the five-minute limit.

---

## 2 Determination of significance [Art 5]

The current proposal for determination of significance has been shared with the stakeholders through the “Public consultation relating to the proposal for maximum capacity thresholds for types B, C and D power-generating modules” running from 19/05/2017 to 20/06/2017 and is available [online](#). The proposed thresholds are the result of several rounds of workshops and discussions with the stakeholders and the authorities. A synthesis of the proposed determination of significance is presented here below.

In line with the NC RfG Art. 5, Elia is proposing the following choice of maximum capacity thresholds for the determination of type:

- Type A
  - $0.8kW \leq P_{MAX}^{Capacity} < 1 MW$  and  $V_{cp} < 110kV$
- Type B
  - $1 MW \leq P_{MAX}^{Capacity} < 25MW$  and  $V_{cp} < 110kV$
- Type C
  - $25MW \leq P_{MAX}^{Capacity} < 75MW$  and  $V_{cp} < 110kV$
- Type D
  - $75MW \leq P_{MAX}^{Capacity}$  or
  - $0.8kW \leq P_{MAX}^{Capacity}$  and  $V_{cp} \geq 110kV$

Where  $P_{MAX}^{Capacity}$  is the maximum (installed) capacity of the power-generating modules and  $V_{cp}$  is the voltage level at the connection point.

The parameters for the determination of significance are graphically illustrated in Figure 1 below.

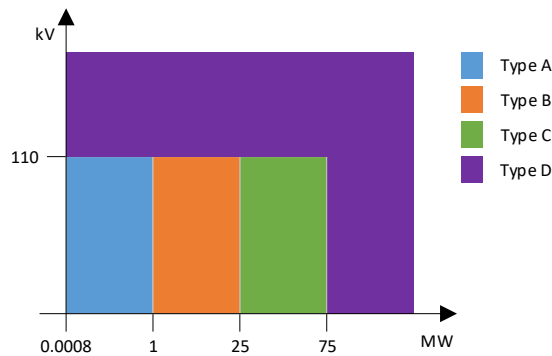

Figure 1 : Graphical representation of the proposed maximum capacity thresholds.

However, Elia is proposing to adapt the requirements for Power-Generating Modules (PGM) with a maximum installed capacity lower than 25MW and with a voltage at the connection point higher or equal to 110kV, in order to reflect the specification of the PGM of the same size with a voltage at the connection point lower or equal to 110kV. The requirements will be adapted via a request for derogation submitted by the relevant system operator or, in this case, the relevant TSO (in line with NC RfG Art. 6.3).

More specifically the following requirements are proposed:

- Type D PGM having a  $0.8kW \leq P_{MAX}^{Capacity} < 1 MW$  will follow the same requirements as type A PGM

- Type D PGM having  $1\text{ MW} \leq P_{MAX}^{Capacity} < 25\text{ MW}$  will follow the same requirements as type B PGM.

A graphical representation of the expected resulting requirements is presented in Figure 2 below.

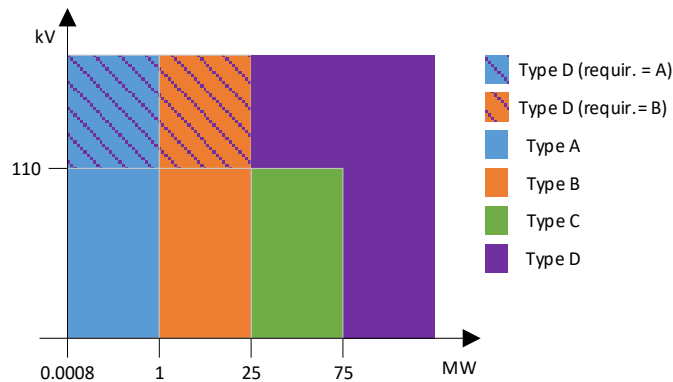

Figure 2 : Graphical representation of the requirements to be followed by PGM depending on the proposed maximum capacity thresholds considering the results of the intended derogation process.

It must be noted that the Power Park Modules (PPM), for which the connection point is located off-shore should follow the same prescriptions as type D PPM units except if specifically defined in the present document.

## 2.1 Conditions for the choice of the maximum capacity thresholds

### 2.1.1 Voltage withstand Capabilities for PGM connected to TSO

*This requirement should be met at the connection point.*

Voltage withstand capabilities are only mentioned in NC RfG for type D PGMs (art 16.2), similar capabilities (cfr. Table 1) are necessary for other PGMs, in order to guarantee safe operation of the grid.

	<b>Voltage Range</b>	<b>Time period for operation</b>
<b>Voltage ranges below 300kV</b>	0.85 pu – 0.90 pu	60 minutes
	0.90 pu – 1.118 pu	Unlimited
	1.118 pu – 1.15 pu	To be agreed between the TSO and the facility owner in the connection agreement
<b>Voltage ranges above 300kV</b>	0.85 pu – 0.90 pu	60 minutes
	0.90 pu – 1.05 pu	Unlimited
	1.05 pu – 1.10 pu	To be agreed between the TSO and the facility owner in the connection agreement

Table 1: Voltage withstand capabilities

The following base values are to be considered as reference for the pu values reported in the Table 1 for PGM connected to TSO network:

- 400kV
- 220kV
- 150kV
- 110kV
- 70kV
- 36kV

---

In case broader or longer voltage withstand capabilities are technically and economically feasible, the power-generating facility owner shall not unreasonably refuse to put them at disposal of the relevant system operator.

### **2.1.2 Other conditions**

For type C Synchronous Power Generating Modules (SPGM), stricter requirements than foreseen by the NC RfG for which regards voltage regulations will be necessary. These requirements are already included in the applicable federal and regional grid codes (TRPV, RTTR and RTTL) for units of the same type and size [4, 7-8-9]. These technical requirements are covered in detail in section 5.5.2.

Elia requests Automatic Voltage Regulation (AVR), Over Excitation Limiter (OEL), Under Excitation Limiter (UEL) and Power System Stabilizer (PSS) functions. The activation and tuning of the PSS function will be required depending on the connection point, size and the characteristic of the SPGM.

This approach is in line with the Implementation Guidance Document, proposed and submitted by ENTSO-e, for national implementation of the network codes on grid connection (IGD) on “Parameters of Non-exhaustive requirements”: it recommends a site specific implementation of the requirement from Art. 19(2)b.(v) through an individual connection contract.



---

## 3 Type A Requirements

In general, all frequency related parameters are being coordinated between TSOs in the Continental Europe synchronous area to guarantee fair contribution among all control areas power generation units and overall resilience and stability of the system. The current requirements are based on the final Implementation Guideline Documents (IGD) that was submitted to public consultation in ENTSO-e website (closed 21 Dec 2017)<sup>2</sup>. In case the IGD would be modified, if relevant, possible future adaptations can be taken into consideration following consultation with the relevant stakeholders.

### 3.1 Frequency Requirements

#### 3.1.1 Frequency withstand capability [Art. 13-1 (a)]

As TSO, Elia defines the following frequency range and minimum time period are as following:

Frequency Range	Duration
[47,5 Hz – 48,5 Hz[	30 minutes
[48,5 Hz – 49,0 Hz[	30 minutes
[49,0 Hz – 51,0 Hz]	Unlimited
]51,0 Hz – 51,5 Hz]	30 minutes

Note: For PGMs connected to distribution grids, the protection settings should not be conflicting with this frequency withstand capability unless in case of local event detection (and not an overall power system event).

Moreover, in application to the paragraphs 13-1 (a)(ii) and (a)(iii), duration of operation in the frequency range from 51,5 Hz to 52,5 Hz shall be dealt with as follows, given that the power-generating facility owner shall not unreasonably withhold consent to apply wider frequency ranges or longer minimum times for operation, taking account of their economic and technical feasibility.

- For units of type B, C and D this shall be agreed between the RSO (Elia) and the generating facility owner in the connection agreement taking into consideration the PGM's possible technical capability.
- For units of type A, the power generating facility owner shall communicate their technical duration capability to the RSO and put it at disposal of the RSO.

#### 3.1.2 Rate Of Change Of Frequency (ROCOF) withstand capability [Art 13.1(b)]

As TSO Elia defines the Rate of Change of Frequency (RoCoF) withstand capability that is defined considering frequency against time profile as depicted in the Figure 3 with explicit measurement technique taking into consideration 2 Hz/s for a duration of 500 ms. For PGM connected to Elia Network and relying on Loss Of Main (LOM) detection based on RoCoF measurement, the protection settings should not be conflicting with RoCoF withstanding capabilities requirements unless in case of local event detection (and not an overall power system event).

---

<sup>2</sup> [https://consultations.entsoe.eu/system-development/entso-e-connection-codes-implementation-guidance-d-4/consult\\_view/](https://consultations.entsoe.eu/system-development/entso-e-connection-codes-implementation-guidance-d-4/consult_view/)

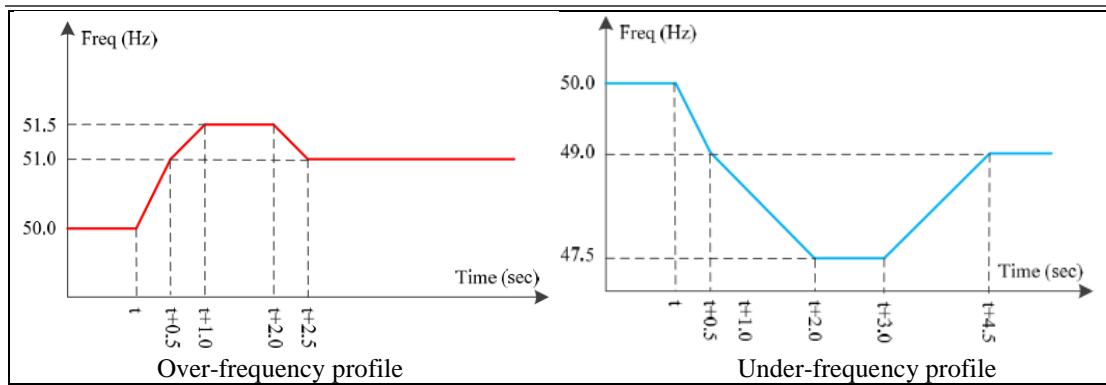

Figure 3: Proposed frequency against time withstanding capabilities.

### 3.1.3 Loss Of Main (LOM) Protection triggered by rate-of-change-of-frequency-type [Art 13.1(b)]

For all PGM, a LOM based on RoCoF may be allowed and defined by the RSO in coordination with the TSO as per the provisions in Article 13. (1) b. In this case, the RoCoF measurement used for LOM protection is used to detect islanding and is not to be confused with the RoCoF immunity requirement defined in the section 3.1.2.

For PGM connected to Elia Network and relying on LOM detection based on RoCoF measurement, the threshold should be higher than 2 Hz/s for a duration of 500 ms. Note that other alternative LOM detection settings should not conflict with frequency withstand capabilities requirements unless in case of local event detection (and not an overall power system event). For technical and safety reasons, lower thresholds can be discussed on a case by case basis.

### 3.1.4 Limited Frequency Sensitive Mode – Over frequency (LFSM-O) [Art. 13-2 (a-g)]

Definition of the non-exhaustive requirements related to LFSM-O function are coordinated between TSOs in the CE synchronous area. Due to the system-wide effect of frequency-related issues, a harmonised setting of these parameters within a synchronous area is desirable. Otherwise adverse impacts can occur, which may aggravate the emergency situations subsequent to the LFSM-O activation. Automatic disconnection and reconnection as referred in 13-2 (b) are not allowed by default.

Elia's current requirement as a TSO takes into consideration the system transient behaviour and the need for an adequate frequency response reaction. The proposal addresses as well the response performance while taking into consideration different PGM technologies.

The PGM response takes into consideration the following aspects as per the Figure 4:

- The dead time ( $T_d$ ) covers the time from the frequency change event until the beginning of the response;
- The step response time ( $T_{sr}$ ) covers the time from the frequency change event until the instant until the response reaches the tolerance range for the first time;
- The Settling time ( $T_s$ ) covers the time from the frequency change event until the instant, from where on the corresponding response remains within the tolerance band of the set value.

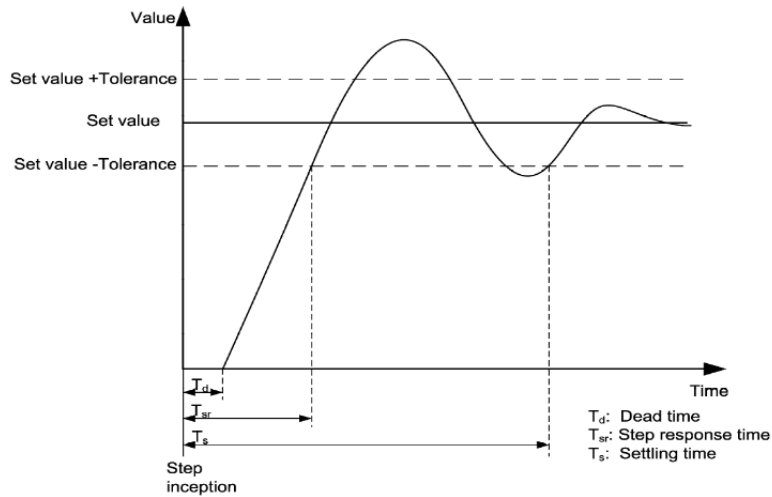

Figure 4: Definition of the PGM response parameters.

The below requirements are common for all PGM:

- The droop setting is 5 % and selectable within the range 2% and 12%;
- Frequency activation threshold 50.2 Hz;
- Dead time: by default as fast as technically possible (no intentional delay), specific provisions could be applicable in agreement with the TSO;
- Once the minimum regulating level is reached, the operation mode shall be continued at the same level (no further decrease for further frequency increase).

The droop is defined as per the following formula:

$$s[\%] = 100 \cdot \frac{|\Delta f| - |\Delta f_1|}{f_n} \cdot \frac{Pref}{|\Delta P|}$$

Where  $\Delta P$  is the change in active power output from the power-generating module.  $f_n$  is the nominal frequency (50 Hz) in the network and  $\Delta f$  is the frequency deviation in the network. At overfrequencies where  $\Delta f$  is above  $\Delta f_1$ , the power-generating module has to provide a negative active power output change according to the droop  $s$ .

NC RfG allows two options for defining  $Pref$  for power park modules: either  $Pmax$  or the actual active power output at the moment the LFSM threshold is reached. In order to achieve an equitable active power response to a high or low frequency event (regardless of the number of power generating modules in operation) the reference active power  $Pref$  is therefore assigned based on the expected capacity operation:

- $Pref$  is by default the actual active (at the moment of activation) for PPM;
- $Pref$  can be alternatively defined as  $Pmax$  for PPM expected to operate mostly at or near maximum capacity (example for offshore wind farms connected to Elia Network).

For SPM:

Parameters (SPGM)	For power increase	For power decrease
<b>Step response time</b>	≤ 5 minutes for an increase of active power of 20 % Pmax (note that the response shall be as fast as technically possible, for example a slow reaction is not applicable in the case of an increase shortly – a few seconds – following a decrease phase)	≤ 8 seconds for a decrease of active power of 45% Pmax
<b>Settling time</b>	≤ 6 minutes for an increase of active power (note that the response shall be as fast as technically possible, for example a slow reaction is not applicable in the case of an increase shortly – a few seconds – following a decrease phase)	≤ 30 seconds for a decrease of active power

For PPM:

Parameters (PPM)	For power increase	For power decrease
<b>Step response time</b>	<i>For wind generation:</i> ≤ 5 seconds for an increase of active power of 20 % Pmax (note that the response shall be as fast as technically possible, for example for operational points lower than 50% of Pmax, a reaction can be slower but shall remain faster than 5 seconds)  <i>For the rest:</i> ≤ 10 seconds for an increase of active power of 50 % Pmax	≤ 2 seconds for a decrease of active power of 50 % Pmax
<b>Settling time</b>	≤ 30 seconds for an increase of active power	≤ 20 seconds for a decrease of active power

For gas turbines and internal combustion engines whose technical specifications do not allow to follow the default requirements described above, the following alternative requirements are applicable:

- If Pmax ≤ 2 MW, at least 1.11% Pmax per second (increasing or decreasing frequency)
- If Pmax > 2 MW, at least 0.33% of Pmax per second (increasing or decreasing frequency)

### 3.1.5 Admissible maximum power reduction with falling frequency [Art. 13-4 and 5]

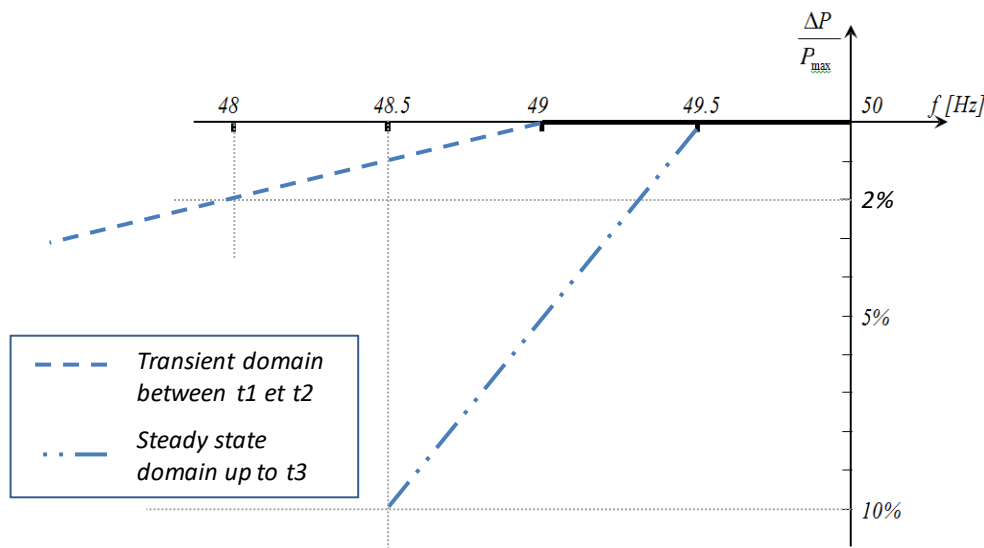

Figure 5: Maximum admissible active power reduction from maximum output for transient and steady state domains.

As TSO, Elia defines the following admissible maximum power reduction with falling frequency requirement.

In the case of PPM, no active power reduction is admissible above 49 Hz, below 49 Hz a maximum active power reduction of 2%/Hz is admissible (although it is not expected as PPMs have no specific technology limitation within this range).

In the case of SPGM, in order to take into consideration system needs and technology limitations, two profiles are covering separately transient domain and steady state domain. In case no technical limitation to maintain active power are existing, active power reduction should be avoided.

Table 2 covers the requirement during the transient period where the PGM are expected to respect the limit of 2 % active power reduction per Hz from maximum output for a duration up to 30 seconds, which would allow other frequency control means to act. During the steady state period, the PGM are allowed if needed to reduce the active power from maximum power output respecting the limit of 10% / Hz.

Table 2: Maximum admissible active power reduction from maximum output requirements.

	Parameter	Requirement
Transient domain	Frequency threshold	49 Hz
	Slope	2 % / Hz
	t 1	≤ 2 seconds
	t 2	30 seconds
Steady state domain	Frequency threshold	49.5 Hz
	Slope	10 % / Hz
	t 3	30 minutes

The standard applicable ambient conditions are defined as following:

- Temperature: 0 °C
- Altitude between 400 m and 500 m
- Humidity: between 15 and 20 g H<sub>2</sub>O/Kg

Compliance will be based on homologation certification. A case by case basis approach (in coordination with the power generator facility owner) is possible for units of Type C and D connected to Elia network.

### 3.1.6 Logical interface to cease active power injection [Art 13-6]

Respecting the applicable regional regulatory provisions, the right to request additional equipment to achieve remote control of the logical interface will be asserted by the relevant system operator in due time.

### 3.1.7 Automatic connection [Art 13-7]

Following large system disturbance, uncontrolled connection of a large amount of generation could result in further degradation of the system stability. Criteria for distributed generation are therefore needed to allow safe automatic connection only during normal operation mode (standard frequency and voltage range).

Elia as a TSO allows automatic connection for all Units of Type A providing the following conditions are satisfied:

1. Frequency to be within 49.9 Hz and 50.1 Hz; and
2. Voltage to be within 0.85 Un<sup>3</sup> and 1.10 Un; and
3. Minimum observation time where the above conditions are satisfied of 60 seconds.

When automatically reconnecting following a network disturbance, the maximum admissible gradient in active power output is 10% of Pmax/min.

<sup>3</sup> For Type A PGM, low voltage can be observed for an extended duration, therefore a lower voltage condition is considered (compared to Type B reconnection) to allow connection during normal operation.

---

For the Type B and Type C connected to Elia Network,), the requirements of article 13.7 of NC RfG remain applicable. Automatic connection is subject to individual authorization to be fixed in their individual connection contracts.

---

## 4 Type B Requirements

In addition to the requirements for type A, and considering the provisions stipulated in the article 14.1, the following is requested.

### 4.1 Frequency stability and active power management

#### 4.1.1 Remote control reduction of active power [Art 14 -2]

Respecting the applicable regional regulatory provisions, the right to request additional equipment to allow active power to be remotely operated will be asserted by Elia as relevant system operator in due time.

#### 4.1.2 Automatic reconnection [Art 14-4 (a-b)]

As referred in 14-4 (a) the conditions, defined by Elia as TSO under which the PGM is capable of reconnecting are defined as following:

1. Frequency within 49.9 Hz and 50.1 Hz; and
2. Voltage within  $0.90 U_n$  and  $1.10 U_n$ ; and
3. Minimum observation time where the above conditions are satisfied of 60 seconds.
4. When reconnecting after a disconnection caused by a network disturbance, a maximum ramping of 10 % Pmax per minute is allowed.

For PGM units connected to Elia Network of Types B, C and D, installation and operation of automatic reconnection are prohibited and subject to authorization in their individual connection contracts on a case by case level.

### 4.2 Instrumentation [Art 14-5]

#### 4.2.1 Structural data: control and electrical protection schemes and settings [Art 14-5 (a + b)]

This requirement is a site specific one: it is to be agreed during the connection process with Elia on a case by case level and fixed in the individual connection contract.

## 4.2.2 Information exchanges [Art 14-5(d)]

Real time measurement requirements:

PGM Type B connected to Elia:

- position of the circuit breakers at the connection point (or another point of interaction agreed with the Elia);
- active and reactive power at the connection point (or another point of interaction agreed with the Elia); and
- net active and reactive power of power generating facility in the case of power generating facility with consumption other than auxiliary consumption.

In case of technical infeasibility to communicate this information, gross active and reactive power of power generating facility could be accepted but it has to be agreed during the connection process with Elia on a case by case level and fixed in the individual connection contract.

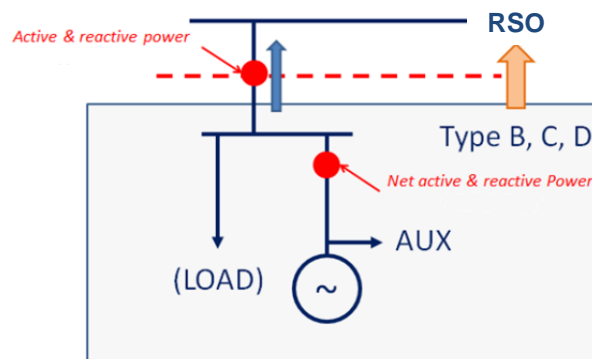

Figure 6: Clarification of the concept of net and gross measurement.

Real-time measurement is defined as a measurement (representation of the current state of a facility) that is refreshed at a rate higher (faster frequency of refreshing) than one minute.

For data related to automatic load-frequency control processes & flexible generation, it shall not be longer than 10 s.

For other purposes, it shall be as fast as possible and, in any case, not longer than one minute.

Note that other real-time measurements could be required by the relevant system operator depending on the location of the PGM, type of prime mover and the availability of measurements.

During the connection procedure of the unit, the exact list of signals to exchange, the communication protocols and infrastructure requirements are communicated by the relevant system operator<sup>4</sup>.

<sup>4</sup> As communication standards can change over time, Elia will make available over time the specifications of the communication protocols on its website.



## 4.3 Type B – SPGM Requirements

### 4.3.1 Reactive power capabilities - SPGM [Art 17-2(a)]

The required reactive capabilities should be met at the HV side of the SPGM step up transformer if existing; otherwise it should be met at the alternator terminals.

The requirements apply to SPGM connected to Elia.

For SPGMs of type B, the requirement for the reactive power provision capability is determined by the Q/P profile represented in Figure 7 where the limitations are based on nominal current at high active power output and by a reactive power (Q) limited to -33% and +33% of  $P_D$ , where  $P_D$  is the maximum active power that can be produced in case of the maximum requested reactive power output (hence equal to  $0.95 \cdot S_{nom}$ ).

With respect to voltages different from  $1pu^5$ , the required  $U/U_c$ -Q/ $P_D$  profile is represented in Figure 8.

Note that the effective resulting available capability of the SPGM at the connection point (that might be different than the one at the SPGM terminals) should be communicated, demonstrated and put at disposal of the relevant system operator during the connection procedure.

The SPGM owner shall not unreasonably withhold consent to use wider reactive capabilities, taking account of their economic and technical feasibility. The unit is therefore expected to not limit its capabilities to comply with the minimum requirement but to use the full capability to support the system stability as stated in its agreement.

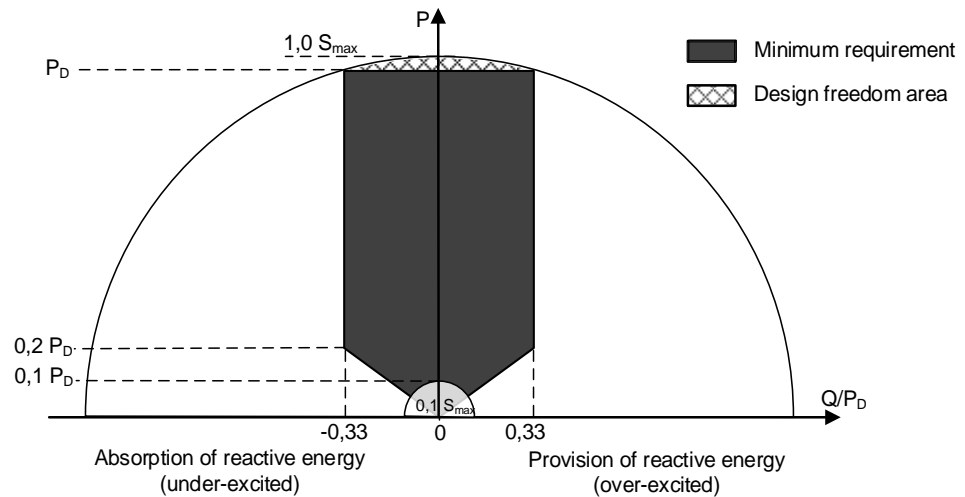
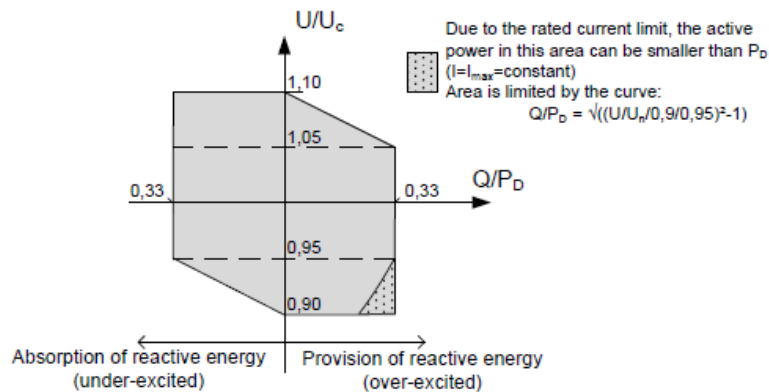

Figure 7: Capability curve for SPGM type B.



<sup>5</sup> The nominal values of voltages are defined in §2.1.1.

Figure 8: U/Uc-Q/PD profile for type B SPGM in order to visualize reactive power requirements for voltages different from 1 pu.

### 4.3.2 Voltage Control SPGM type B [Art 17-2 (b)]

With regards to the voltage control system, a synchronous power-generating module (SPGM) of type B shall be equipped with a permanent automatic excitation control system that can provide constant alternator terminal voltage at a remotely selectable setpoint without instability over the entire operating range of the synchronous power-generating module. This means that this SPGM shall be capable to control voltage with 2 control modi:

- Qfix: maintain a constant reactive power within the P/Q capabilities of Figure 7.
- Q(U): maintain a constant alternator voltage within the P/Q capabilities of Figure 7.
- For all those control modes the setpoint should be remotely selectable.

### 4.3.3 Fault-ride through for symmetrical and asymmetrical faults for SPGM [Art 14-3]

*This requirement defined by Elia as TSO should be met at the connection point.*

The SPGM should be able to support the network during fast transient voltages and network short-circuits for which the profile of the voltage versus time is referred as Fault-Ride-Through (FRT). SPGM shall fulfil the requirements in the figure below, where the SPGM shall remain connected to the grid as long as the voltage of the phase having the lower voltage is above the profile.

It is recommended however to remain connected as long as the technical capability of the PGM would allow. The same profile applies for asymmetrical faults.

The proposed Fault-Ride-Through parameters are presented in the figure below.

A voltage  $U=1 \text{ pu}^6$  represents the rated voltage (phase-to-phase) at the connection point.

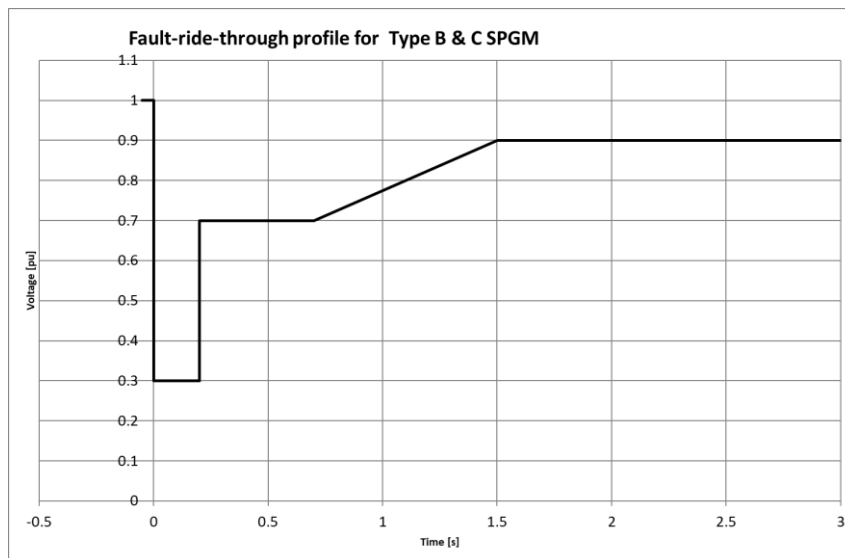

Figure 9: FRT requirement for SPGM type B and C.

Table 3: Parameters of the FRT requirements for SPGM of type B and C.

Voltage parameters [pu]	Time parameters [seconds]
$U_{ret}= 0.3$	$t_{clear}= 0.2$

<sup>6</sup> The nominal values of voltages are defined in §2.1.1.

$U_{\text{clear}} = 0.7$	$t_{\text{rec1}} = t_{\text{clear}}$
$U_{\text{rec1}} = 0.7$	$t_{\text{rec2}} = 0.7$
$U_{\text{rec2}} = 0.9$	$t_{\text{rec3}} = 1.5$

The parameters considered for Fault-Ride-Through capability calculations (e.g. pre and post fault short circuit capacity, pre-fault operating point of the SPGM...) are communicated by the TSO on request of the power-generating facility owner during the connection process.

#### 4.3.4 Post-fault active power recovery - SPGM [Art 17-3]

It is required that SPGM of Type B are able to provide post-fault active power recovery as the unit remains connected to the network.

For SPGMs, the values of the magnitude and time for the active power recovery will be a site specific specification: it is to be agreed during the connection process with the TSO on a case by case level and fixed in the individual connection contract.

### 4.4 Type B – PPM Requirements

#### 4.4.1 Fault-ride through for symmetrical and asymmetrical faults - PPM [Art 14.3]

*This requirement defined by Elia as TSO should be met at the connection point.*

The PPM unit should be able to support the network during fast transient voltages and network short-circuits for which the profile of the voltage versus time is referred as Fault-Ride-Through (FRT). PPM shall fulfil the requirements in Figure 10 (the evolution of the minimum voltage at the Connection Point), where the PPM shall remain connected to the grid as long as the voltage of the phase having the lower voltage is above the profile of Figure 10. It is recommended however to remain connected as long as the technical capability of the PPM would allow it. The same profile applies for asymmetrical faults.

The proposed fault-ride-through parameters are presented in Table 4.

A voltage  $U=1 \text{ pu}^7$  represents the rated voltage (phase-to-phase) at the connection point.

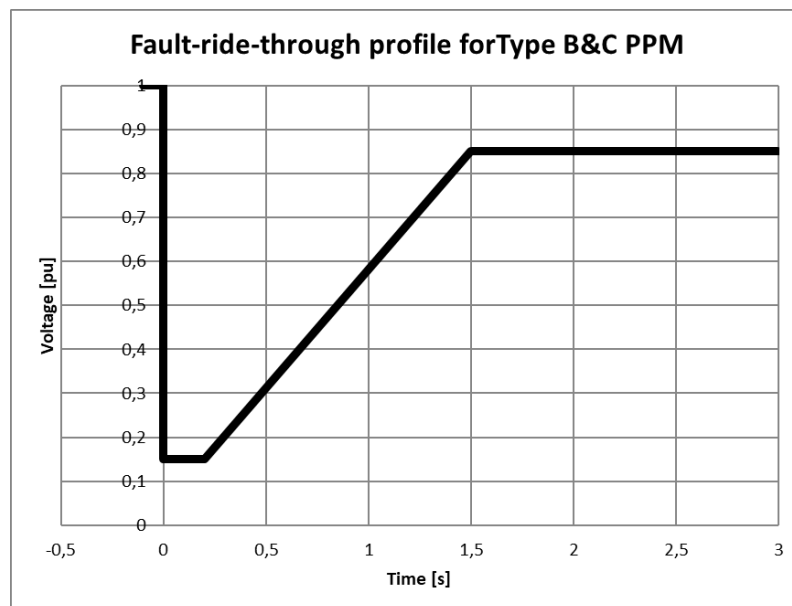

Figure 10: FRT requirement for PPM type B and C.

<sup>7</sup> The nominal values of voltages are defined in §2.1.1.

Table 4: Parameters of the FRT requirements for PPM of type B and C.

Voltage parameters [pu]	Time parameters [seconds]
Uret=Uclear=Uret1= 0.15	tclear=trec1=trec2= 0.2
Urec2 = 0.85	trec3=1.5

#### 4.4.2 Reactive capabilities - PPM [Art 20-2(a)]

The required reactive capabilities should be met at the HV side of the step up transformer if existing; otherwise they should be met at the inverter terminals.

For PPMs of type B, the requirement for the reactive power provision capability is determined by the Q-P profile represented in Figure 11 where the limitations are based on nominal current at high active power output and by a power factor (cos(phi)) defined by the 2 points at Q= -33% and +33% of  $P_D$ , where  $P_D$  is the maximum active power that can be produced in case of the maximum requested reactive power output (hence equal to  $0.95 \cdot S_{nom}$ ).

With respect to voltages different from 1pu, the required  $U/U_c$ -Q/ $P_D$  profile is represented in Figure 12.

Note that the effective resulting available capability of the PPM at the *connection point* (that can be different than the one at the PPM terminal) should be communicated, demonstrated and put at disposal of the relevant system operator during the connection procedure.

In case the PPM unit has the capability of voltage regulation for wider values than the minimum requirement area shown in Figure 11, the PPM owner shall not unreasonably withhold consent to put them at disposal of the RSO, taking account of their economic and technical feasibility. The unit is therefore expected to not limit its capabilities to comply with the minimum requirement but to use the full capability to support the system stability as stated in its agreement.

In this case, the settings of the controllers should be agreed with the relevant system operator.

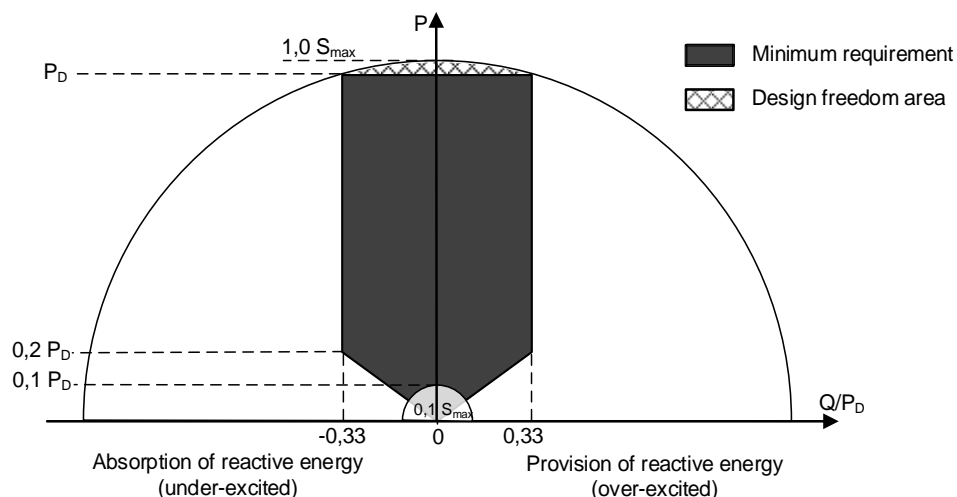

Figure 11: Capability curve for PPM type B.

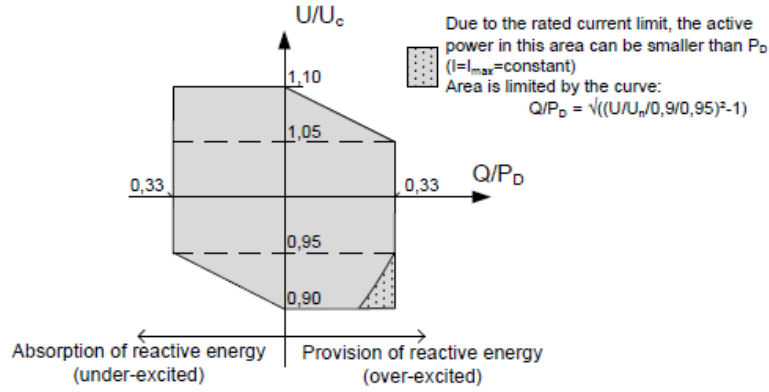

Figure 12:  $U/U_c$ - $Q/P_D$  profile for type B PPM in order to visualize reactive power requirements for voltages different from 1 pu.

#### 4.4.3 Fault Current & dynamic voltage support [Art 20-2 (b and c)]

The PPM unit shall be able to inject/absorb additional reactive current compared to the pre-fault state during low and high voltage conditions up to the maximum of its capability.

The additional injected/absorbed reactive current shall be function of the positive sequence voltage at the connection point depending on the available capability of the PPM.

The resulting fast current injection at the point of connection should be calculated and shared with the TSO by simulation in terms of active and reactive current components.

The requested additional reactive current characteristic injection is illustrated in Figure 13.

For voltages within the deadband  $[\Delta V_-^{act}, \Delta V_+^{act}]$ , the PPM unit should follow the normal voltage control mode.

The injection or absorption of additional reactive current shall be delivered by the PPM with a minimal delay from the detection of the over/undervoltage,  $t_{Iq}^{act}$ . The functionality should remain active for a minimum time of  $t_{Iq}^{on}$  and can be deactivated if the voltage returns and remains within  $[\Delta V_-^{act}, \Delta V_+^{act}]$  for a time longer than  $t_{Iq}^{off}$ .

The parameters of this functionality lying within the normal operational range of the installation as well as the delays of activation, dead band and duration of the activation are to be agreed during the connection process on a case by case level and fixed in the individual connection contract with the relevant system operator (it might be the DSO or Elia) in coordination with the relevant TSO. The parameter setting of this functionality is therefore site specific.

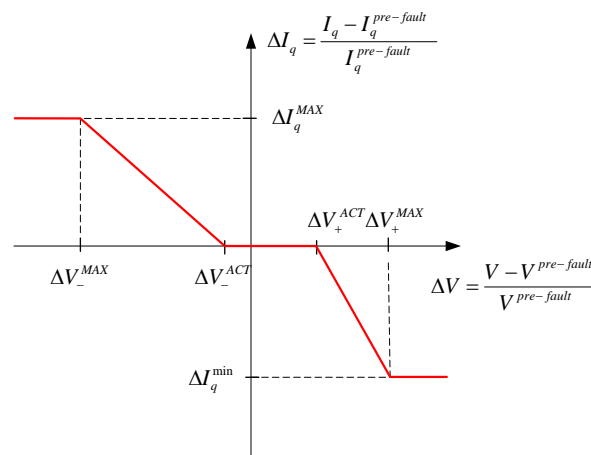

Figure 13: Injection of additional reactive current.

For the reliable detection of asymmetric faults, the PPM unit shall contribute to the fault with positive, negative and zero-sequence current. The short-circuit contribution is to be agreed during the connection process on a case by case level and fixed in the individual connection contract with the relevant system operator in coordination with the relevant TSO. The parameter setting of this functionality is therefore site specific.

---

#### **4.4.4 Post-fault active power recovery [Art 20-3]**

For PPMs, the parameters of this functionality and its activation should be agreed during the connection process with the relevant TSO on a case by case approach and fixed in the individual connection contract. These parameters are thus a site specific requirement.

## 5 Type C Requirements

In addition to the relevant specifications for type B, and considering the provisions stipulated in the article 15.1, the following is requested.

### 5.1 Frequency stability & Active Power management

#### 5.1.1 Active Power Controllability and Control Range [Art. 15-2 (a-b)]

The relevant TSO shall establish the period within which the adjusted active power set point must be reached. The relevant TSO shall specify a tolerance (subject to the availability of the prime mover resource) applying to the new setpoint and the time within which it must be reached as shown in the figure below.

The minimum period to reach the active power setpoint would be defined in the connection contract as per the technical ramping capabilities. Therefore, dependent on the technology, it is agreed during the connection process on a case by case level and fixed in the individual connection contract with the relevant system operator. These parameters are a site specific requirement.

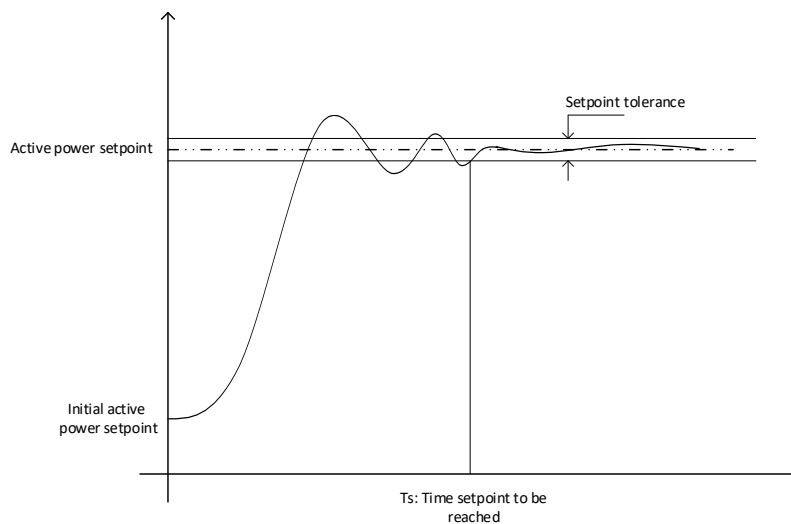

Figure 14: Tolerance and time duration for application of new set point of active power.

With respect to local measures where the automatic remote device is out of service, the minimum time for the setpoint to be reached is equal to 15 minutes for a tolerance of 10% of the active power setpoint.

#### 5.1.2 Limited frequency sensitive mode – under frequency (LFSM-U) [Art. 15-2 (c)]

Similarly to the LFSM-O requirements, in order to take into consideration the system transient behaviour and the need for an adequate frequency response reaction, the actual requirement defined by Elia as TSO addresses as well the response performance while taking into consideration different PGM technologies. The delivery of the active power frequency is subject to the aspects covered in the paragraph 15 (2) (c) ii.

The below requirements are common for all PGM:

- The drop setting is 5 % and selectable within the range 2% and 12%;
- Frequency activation threshold 49.8 Hz;
- Dead time: as fast as technically possible, no intentional delay is foreseen.

The droop is defined as per the following formula:

$$s[\%] = 100 \cdot \frac{|\Delta f| - |\Delta f_1|}{fn} \cdot \frac{P_{ref}}{|\Delta P|}$$

Where  $\Delta P$  is the change in active power output from the power-generating module.  $fn$  is the nominal frequency (50 Hz) in the network and  $\Delta f$  is the frequency deviation in the network. At underfrequencies where  $\Delta f$  is below  $\Delta f_1$  the power-generating module has to provide a positive active power output change according to the droop  $s$ .

NC RfG allows for two options for defining  $P_{ref}$  for power park modules: either  $P_{max}$  or the actual active power output at the moment the LFSM threshold is reached. In order to achieve an equitable active power response to a high or low frequency event (regardless of the number of power generating modules in operation) the reference active power  $P_{ref}$  is therefore assigned:

- $P_{ref}$  is by default the actual active (at the moment of activation) for PPM;
- $P_{ref}$  can be alternatively defined as  $P_{max}$  for PPM expected to operate mostly at or near maximum capacity (example for offshore wind farms connected to Elia Network).

For SPGM:

Parameters (SPGM)	For power increase	For power decrease
<b>Step response time</b>	$\leq 5$ minutes for an increase of active power of 20 % $P_{max}$ (note that the response shall be as fast as technically possible, for example a slow reaction is not applicable in the case of an increase shortly –few second- following a decrease phase)	$\leq 8$ seconds for a decrease of active power of 45% $P_{max}$
<b>Settling time</b>	$\leq 6$ minutes for an increase of active power (note that the response shall be as fast as technically possible, for example a slow reaction is not applicable in the case of an increase shortly –few second- following a decrease phase)	$\leq 30$ seconds for a decrease of active power

For PPM:

Parameters (PPM)	For power increase	For power decrease
<b>Step response time</b>	<p><i>For wind generation:</i>  <math>\leq 5</math> seconds for an increase of active power of 20 % <math>P_{max}</math> (note that the response shall be as fast as technically possible, for example for operational points lower than 50% <math>P_{max}</math>, a reaction can be slower but shall remain faster than 5 seconds)</p> <p><i>For the rest:</i>  <math>\leq 10</math> seconds for an increase of active power of 50 % <math>P_{max}</math></p>	$\leq 2$ seconds for a decrease of active power of 50 % $P_{max}$
<b>Settling time</b>	$\leq 30$ seconds for an increase of active power	$\leq 20$ seconds for a decrease of active power

For gas turbines and internal combustion engines whose technical specifications do not allow to follow the default requirements described above, the following alternative requirements are applicable:

- If  $P_{max} \leq 2$  MW, at least 1.11%  $P_{max}$  per second (increasing or decreasing frequency)
- If  $P_{max} > 2$  MW, at least 0.33% of  $P_{max}$  per second (increasing or decreasing frequency)

### 5.1.3 Frequency Sensitive Mode [Art. 15.2.d]

The setting parameters for the frequency sensitive mode defined by Elia as TSO are summarized in below:

Parameters	Values and ranges
Active power range $ \Delta P /P_{max}$	A range between 2% and 10%



Frequency response insensitivity	$ \Delta f_i $	Maximum 10 mHz
	$ \Delta f_i /f_n$	Maximum 0,02 %
Frequency response deadband	0 mHz and adjustable between 0 et 500 mHz (a combined response insensitivity, possible delay and response dead band shall be limited to 10 mHz)	
Droop $s_i$	Adjustable between 2% and 12% to guaranty a full activation $ \Delta P_1 /P_{max}$ for the maximum frequency activation (200 mHz)	
Pref	Defined as $P_{max}$ for SPGM Defined as actual Active Power output when FSM threshold is reached or $P_{max}$ in alignment with the provisions fixed for LFSM-O and LFSM-U.	

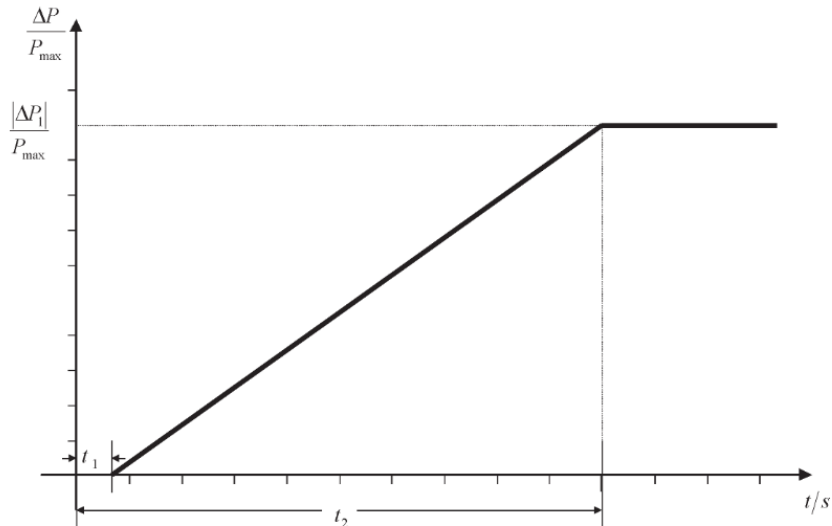

Figure 15: Active power response capability.

With respect to the paragraph 15.2.(d).iii, the requirements in term of time response characteristics as described in the Figure 4 are defined as below:

- $t_1$ : Maximum 2 seconds for PGM with inherent inertia and Maximum 500 milliseconds for PGM without inherent inertia
- $t_2$ : Maximum 30 seconds (15 seconds for 50% of full active power activation)
- full activation duration: minimum 15 minutes

#### 5.1.4 Frequency restoration control [Art 15-2(e)]

Specifications aligned with synchronous area TSOs in compliance with the System Operation Guidelines (Articles 154, 158, 161, 165) [10] and currently applicable requirement of Elia as TSO, are to be agreed during the connection process with the relevant system operator on a case by case level and fixed in the individual connection contract.

#### 5.1.5 Real-time monitoring of FSM [Art 15-2(g)]

Defined coherently as per the System Operation Guidelines (Article 47) [10] and currently applicable requirement of Elia as TSO are to be agreed during the connection process with the relevant system operator on a case by case level and fixed in the individual connection contract.

#### 5.1.6 Automatic disconnection for voltage outside ranges [Art 15-3]

The automatic disconnection due to voltage outside ranges is not requested in a generic manner. This requirement is considered site specific. The activation, values and settings of this functionality should be agreed during the connection process by the relevant system operator in coordination with the relevant TSO on a case by case level and fixed in the individual connection contract with the relevant system operator. The grid user will have to validate the settings of the disconnection relays with the

---

relevant TSO. Automatic reconnection to the network after a disconnection is not allowed and should be coordinated with the relevant TSO.

### **5.1.7 Rates of change of active power output [Art 15-6(e)]**

Minimum and maximum active power ramping limits (upward and downward) should be agreed during the connection process by the relevant system operator in coordination with the relevant TSO on a case by case level and fixed in the individual connection contract with the relevant system operator.

The ramping limits are to be defined site specifically taking into consideration the prime mover technology in compliance the System Operation Guidelines [10]. These limits are to be defined by the relevant system operator in coordination with the TSO.

## **5.2 System restoration [Art 15-5]**

Different from the current Federal Grid Code and regional grid codes (TRPV, RTTR and RTTL) [4, 7-8-9], the NC RfG asks for more strict behaviour for system restoration.

### **5.2.1 Capability to take part in island operation [Art 15.5(b)]**

The PGMs of type C are not required to take part to island operation. Nevertheless they are required to be able to trip to houseload and be able to quick-resynchronize as specified in 15-5(c).

### **5.2.2 Quick resynchronization capability [Art 15-5(c)]**

More specifically with regard to quick re-synchronisation capability:

- i. In case of disconnection of the power-generating module from the network, the power-generating module shall be capable of quick re-synchronization in line with the protection strategy agreed between the relevant system operator in coordination with the relevant TSO and the power-generating facility.

The quick re-synchronization strategy is to be agreed with the relevant TSO on a case by case basis.

- ii. A power-generating module with a minimum re-synchronization time greater than 15 minutes after its disconnection from any external power supply must be designed to trip to houseload from any operating point in its P-Q-capability diagram. In this case, the identification of houseload operation must not be based solely on the system operator's switchgear position signals.

The strategy of identification of houseload operation is to be agreed with the relevant TSO on a case by case basis.

- iii. Power-generating modules shall be capable of continuing operation following tripping to houseload, irrespective of any auxiliary connection to the external network. The minimum operation time shall be specified by the relevant system operator in coordination with the relevant TSO, taking into consideration the specific characteristics of prime mover technology. For PGMs connected to TSO network, the minimum operation time is to be defined during the connection process.

## **5.3 Instrumentation, simulation and protection**

### **5.3.1 Loss of angular stability or loss of control [Art 15.6(a)]**

The power generating facility owner and the relevant system operator in coordination with the TSO shall agree during the connection process about the criteria to detect loss of angular stability or loss of control and consequent disconnection of the unit. These parameters will be taken in the appendices of the individual connection agreement.

---

### **5.3.2 Instrumentation [Art 15.6(b)]**

The quality of supply parameters, the triggers for activation of fault recorders and power oscillation and relative sampling rates and the modality of access to the recorded data is to be defined in agreement with the TSO and/or relevant system operator (in accordance with art 15-6) during the connection process. These parameters will be taken in the appendices of the individual connection agreement.

### **5.3.3 Simulation models [Art 15.6(c)]**

Simulation models able to reflect the behaviour of the power generating module in steady state and electromechanical dynamic simulation (phasor-based) are required by ELIA for all units. A model to represent Electro Magnetic Transient phenomena can be required on a site specific base for every concerned unit.

The format of the model, as well the provision of documentation and short circuit capacity should be coordinated by the relevant system operator with the TSO during the connection process. These parameters will be taken in the appendices of the individual connection agreement.

### **5.3.4 Devices for system operation and security [Art 15.6(d)]**

The installation of additional devices for system operation and security should be agreed between the RSO or TSO and the Power Generating Facility Owner (PGFO) on a site specific base.

### **5.3.5 Earthing of the neutral point at the network side of the step-up transformer [Art 15.6(f)]**

The relevant system operator shall specify the earthing arrangement of the neutral-point at the network side of step-up transformers during connection process. These parameters will be taken in the appendices of the individual connection agreement.

## **5.4 Voltage control mode (for SPGM and PPM) [Art 19-2(a) and Art 21-3(d)]**

*This requirement should be met at the connection point.*

By default the control mode is a voltage droop/slope mode. However site specific (during the conformity study process with the relevant system operator and the connection process) a different control mode can be requested/agreed.

These specifications are given in line with the current provisions in the applicable Federal and regional grid codes (TRPV, RTTR and RTTL) [4, 7-8-9]. The power generating modules of types C and D are considered regulating units. They must be able to adapt their reactive power injected at the *connection point*:

- Automatically in case of slow or fast variations of the grid voltage. This has to happen according to a reactive droop (FGC Art. 73);
- Through change of the controller setpoint on request of the Transmission System Operator. This request is quantified in Mvar measured at the connection point. The change of setpoint shall be initiated immediately after reception of the request;
- Reactive power exchange with the TSO network to control the voltage covering at least the 0.90 to 1.10 pu voltage range should be in steps not greater than 0.01 pu;
- The reactive power output shall be zero when the grid voltage value at the connection point equals the voltage setpoint.

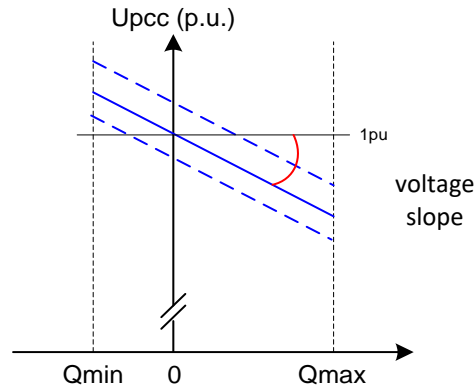

Figure 16: Principle of the voltage and reactive power control.

Automatic voltage control has to fulfil a reactive droop requirement (Figure 16). On request of the Transmission System Operator, the setpoint of the controller can be modified in real-time, and the operating point is to be shifted to a parallel line (dashed) with the same slope (illustrated in Figure 16). The control loop gain will be agreed between the Transmission System Operator and the PGM operator (before first energization) so that  $\alpha_{eq}$  lies between 18 and 25, as expressed in the following:

$$\alpha_{eq} = - \frac{\left( \frac{\Delta Q_{net}}{0,45 \times P_{nom}} \right)}{\left( \frac{\Delta U_{net}}{U_{norm,exp}} \right)}$$

Where

- $U_{net}$  is the voltage measured at the Connection Point
- $U_{norm,exp}$  is the normal exploitation voltage at the Connection Point
- $Q_{net}$  is the injected reactive power measured at the Connection Point

The  $\alpha_{eq}$  values can be transformed and are hence totally in line the value of a slope having a range of at least 2 to 7% as is mentioned in RfG art. 21.3d(ii).

## 5.5 Type C SPGM Requirements

### 5.5.1 Reactive power capability SPGMs [Art 18-2]

*This requirement should be met at the connection point.*

All SPGMs of type C (and type D) should be compliant with the requested reactive power capabilities of the U-Q/Pmax diagram in Figure 17. For every connection demand, it should be proven that the SPGM is able to operate within the range shown in the figure below. The maximum voltage value of 1.10pu should be considered as 1.05pu in case of connection to voltage level above 300kV.

Note that the available capability of the SPGM (which could be wider than the minimum requirement) should be communicated, demonstrated and put at disposal of the relevant system operator.

The SPGM owner shall not unreasonably withhold consent to use wider reactive capabilities, taking account of their economic and technical feasibility. The unit is therefore expected to not limit its capabilities to comply with the minimum requirement but to use the full capability to support the system stability as stated in its agreement.

The SPGM should be in state to deliver the reactive capacity shown in figure above for the whole operating range of active power, conform to art 18.2(c).

The speed of reaction within the capability curve is site specific and will be determined during the connection conformity process (e.g. EDS) and specified in the contractual agreement.

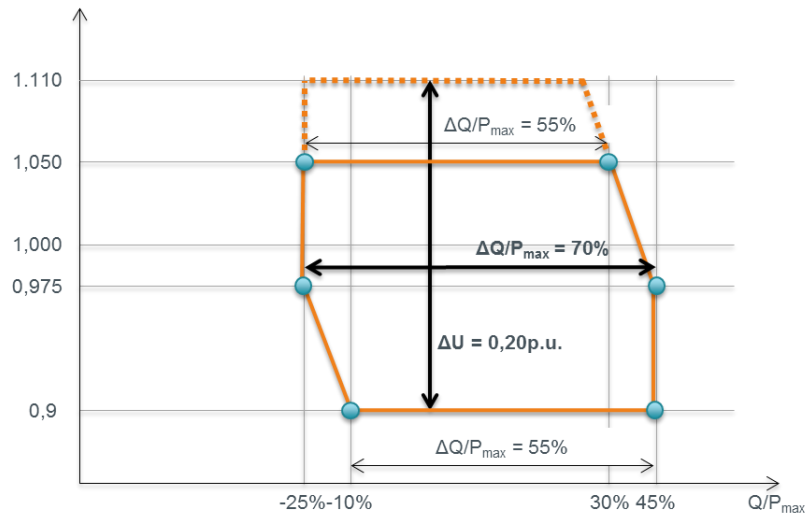

Figure 17: Capability curve for SPGM type C and D.

### 5.5.2 Voltage control requirements for SPGM type C

The proposed requirements for voltage control for type C units are in line with the current provisions in the applicable Federal and regional grid codes (TRPV, RTTR and RTTL) [4, 7-8-9] for which regards the functionalities and parameter settings of the automatic voltage regulator with regard to steady-state voltage and transient voltage control and the specifications and performance of the excitation control system. The functionality shall include:

- bandwidth limitation of the output signal to ensure that the highest frequency of response cannot excite torsional oscillations on other power-generating modules connected to the network;
- an underexcitation limiter to prevent the AVR from reducing the alternator excitation to a level which would endanger synchronous stability;
- an overexcitation limiter to ensure that the alternator excitation is not limited to less than the maximum value that can be achieved whilst ensuring that the synchronous power-generating module is operating within its design limits;
- a stator current limiter;
- a Power System Stabilizer (PSS) function to attenuate power oscillations, requested by the relevant TSO (i.e. the activation and tuning of the PSS function will be agreed depending on the connection point, size and the characteristic of the SPGM).

## 5.6 Type C PPM Requirements

### 5.6.1 Synthetic inertia for PPM [Art 21-2]

Synthetic inertia functionality is not required in the current General Requirements.

### 5.6.2 Reactive capabilities - PPM [Art 21-3(a-c)]

*This requirement should be met at the connection point.*

A PPM of type C shall be capable to deliver reactive power within the Q-P profile described in Figure 18.

For every voltage at the Connection Point between 90 % and 110 % of  $U_{nom}$  and for any value of the active power output between  $P_{min}$  (0.2 pu of  $P_{nom}$ ) and  $P_{nom}$ , the PPM shall be able to produce or consume - at least - any reactive power at the connection point within the area limited by Q1, Q2, Q3 and Q4 (Figure 18).



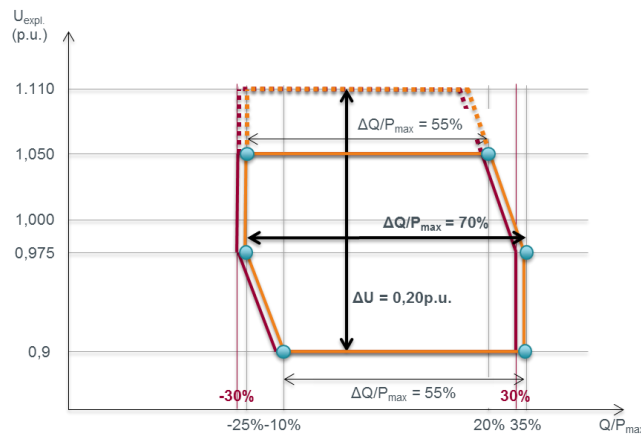

Figure 19: U-Q/Pmax profile for a type C PPM (dashed for nominal voltages above 300kV).

Note that the available capability of the PPM (which could be wider than the minimum requirement) should be communicated, demonstrated and put at disposal of the relevant system operator.

The PPM owner shall not unreasonably withhold consent to use wider reactive capabilities, taking account of their economic and technical feasibility. The unit is therefore expected to not limit its capabilities to comply with the minimum requirement but to use the full capability to support the system stability as stated in its agreement.

The speed of reaction within the capability curve is site specific and will be determined during the connection conformity process (e.g. EDS) and specified in the contractual agreement.

### 5.6.3 Voltage control - PPM [Art 21-3 (d) and (e)]

*This requirement should be met at the connection point.*

The PPM shall be capable of providing reactive power automatically by either voltage control mode, reactive power control mode or power factor control mode.

The requirement for the prioritizing of active or reactive power contribution is to be defined as site specific by the relevant system operator. It has to be agreed during the connection process with the relevant system operator in coordination with the relevant TSO on a case to case basis and fixed in the individual connection contract with the relevant system operator.

---

## 6 Type D Requirements

In addition to the relevant specifications for type C, and considering the provisions stipulated in the article 16.1, the following is requested.

### 6.1 Voltage Control

#### 6.1.1 Voltage withstand capability [Art 16-2(a & b)]

*This requirement should be met at the connection point.*

Beside the requirements mentioned in paragraph 2.1.1, the required voltage withstand capabilities for type D SPGMs should follow the requirements as described in the EU NC RfG art. 16.2:

	<b>Voltage Range</b>	<b>Time period for operation</b>
<b>Voltage ranges below 300kV</b>	0.85 pu – 0.90 pu	60 minutes
	0.90 pu – 1.118 pu	Unlimited
	1.118 pu – 1.15 pu	20 minutes
<b>Voltage ranges above 300kV</b>	0.85 pu – 0.90 pu	60 minutes
	0.90 pu – 1.05 pu	Unlimited
	1.05 pu – 1.10 pu	20 minutes

The following base values are to be considered as reference for the pu values reported in the table above for PGM connected to TSO network:

- 400kV
- 220kV
- 150kV
- 110kV
- 70kV
- 36kV

In case wider voltage ranges or longer time periods for operation are economically and technically feasible, the power-generating facility owner shall not unreasonably refuse to put them at disposal of the relevant system operator.

#### 6.1.2 Automatic disconnection for voltage outside ranges [Art 16-2(c)]

No automatic disconnection is foreseen as a generic requirement.

The terms and settings for automatic disconnection should be agreed during the connection process with the PGFP by the relevant system operator in coordination with the relevant TSO on a case by case basis and fixed in the individual connection contract with the relevant system operator.

### 6.2 Resynchronization [Art 16-4]

The relevant system operator and the PGFO should agree on the settings of the synchronization devices during the connection process on a case by case basis and fixed in the individual connection contract with the relevant system operator.



## 6.3 Type D SPGM Requirements

### 6.3.1 Fault-ride through for symmetrical and asymmetrical faults – SPGM [Art 16-3]

This requirement defined by Elia as TSO should be met at the connection point.

The SPGM unit should be able to support the network during fast transient voltages and network short-circuits for which the profile of the voltage versus time is referred as Fault-Ride-Through (FRT). SPGM unit shall fulfil the requirements in the Figure below (the evolution of the minimum voltage at the Connection Point), where the SPGM shall remain connected to the grid as long as the voltage of the phase having the lower voltage is above the profile shown in the Figure below.

It is recommended however to remain connected as long as the technical capability of the SPGM would allow. The same profile applies for asymmetrical faults.

The proposed fault-ride-through parameters<sup>9</sup> following FRT are presented in the table below  
A voltage  $U=1$  pu represents the rated voltage (phase-to-phase) at the connection point.

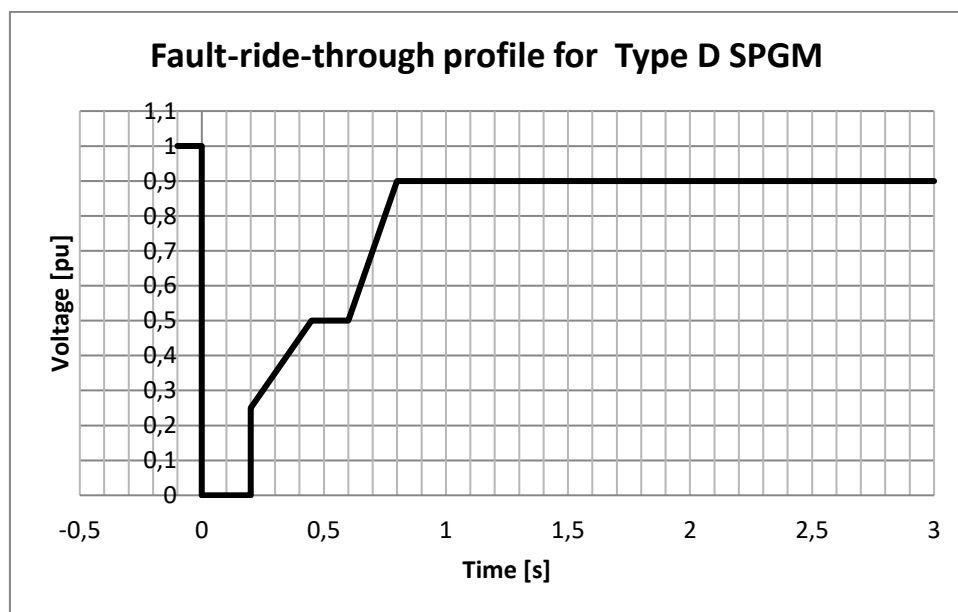

Figure 20: FRT requirement for SPGM type D.

Table 5: Parameters of the FRT requirements for SPGM of type D.

Voltage parameters [pu]	Time parameters [seconds]
$U_{ret} = 0$	$t_{clear} = 0.2$
$U_{clear} = 0.25$	$t_{rec1} = 0.45$
$U_{rec1} = 0.5$	$t_{rec2} = 0.6$
$U_{rec2} = 0.9$	$t_{rec3} = 0.8$

The parameters considered for fault-ride through capability calculations (e.g. pre and post fault short circuit capacity, pre-fault operating point of the PGM...) are communicated by the TSO on request of the power-generating facility owner during the connection process.

<sup>9</sup> Note that the parameter are not the coordinates of the FRT curve but must be interpreted following the specification of the RfG, art. 14.3 and presented, for information, in appendix I.

---

### **6.3.2 Voltage stability SPGM [Art 19-2]**

In line with the current provisions in the applicable Federal and regional grid codes (TRPV, RTTR and RTTL) [4, 7-8-9] for which regards the functionalities and parameter settings of the automatic voltage regulator with regards to steady-state voltage and transient voltage control and the specifications and performance of the excitation control system. The latter shall include:

- i. bandwidth limitation of the output signal to ensure that the highest frequency of response cannot excite torsional oscillations on other power-generating modules connected to the network;
- ii. an underexcitation limiter to prevent the AVR from reducing the alternator excitation to a level which would endanger synchronous stability;
- iii. an overexcitation limiter to ensure that the alternator excitation is not limited to less than the maximum value that can be achieved whilst ensuring that the synchronous power-generating module is operating within its design limits;
- iv. a stator current limiter; and
- v. a PSS function to attenuate power oscillations, requested by the relevant TSO (: the activation and tuning of the PSS function will be required depending on the connection point, size and the characteristic of the concerned SPGM).

### **6.3.3 Technical capabilities to support angular stability under fault conditions for SPGM [Art 19-3]**

No generic capabilities regarding SPGM to aid angular stability under fault condition are requested to all units. The TSO and the PGFO should agree on these capabilities during the connection process on a case by case basis and fixed in the individual connection contract with the relevant TSO.

## **6.4 Type D – PPM**

### **6.4.1 Fault-ride through for symmetrical and asymmetrical faults – PPM [Art. 16-3]**

*This requirement defined by Elia as TSO should be met at the connection point.*

The PPM unit should be able to support the network during fast transient voltages and network short-circuits for which the profile of the voltage versus time is referred as Fault-Ride-Through (FRT). PPM unit shall fulfil the requirements in Figure 21, where the PPM unit shall remain connected to the grid as long as the voltage of the phase having the lower voltage is above the profile of the figure below. It is recommended however to remain connected as long as the technical capability of the PPM would allow. The same profile applies for asymmetrical faults.

The proposed fault-ride-through parameters are presented in Table 6.

A voltage  $U=1$  pu represents the rated voltage (phase-to-phase) at the connection point.

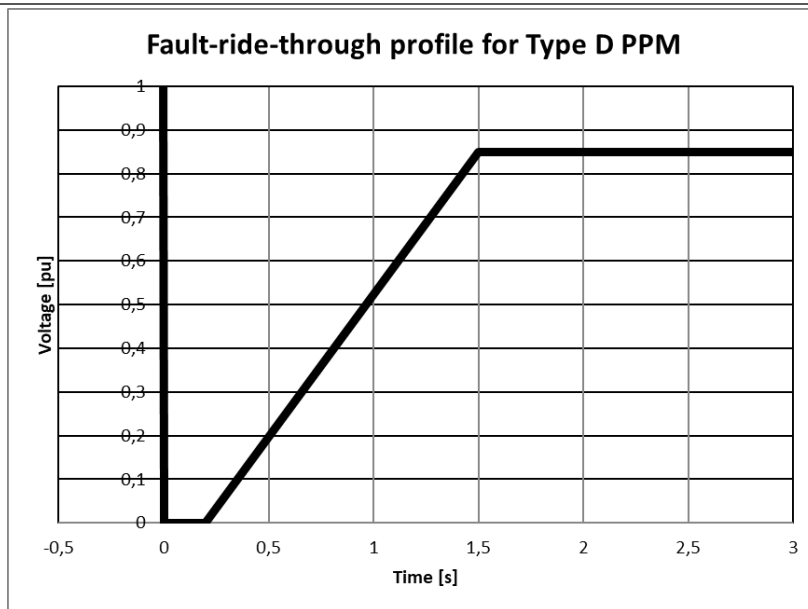

Figure 21: FRT requirement for PPM type D.

Table 6: Parameters of the FRT requirements for PPM of type D.

<b>Voltage parameters [pu]</b>	<b>Time parameters [seconds]</b>
Uret=Uclear=Uret1= 0	Tclear=trec1=trec2= 0.2
Urec2 = 0.85	trec 3=1.5

---

## 7 Acronyms

DCC	Demand Connection Code PGM Power Generating Module
FRT	Fault Ride Through
LFSM	Limited Frequency Sensitive Mode
LOM	Loss Of Main
PGFO	Power Generating Facility Owner
PPM	Power Park Module
PSS	Power System Stabilizer
RfG	Requirement for Grid connection of generators
RoCoF	Rate of Change of Frequency
RSO	Relevant System Operator
RTTL	Règlement Technique pour la gestion du réseau de Transport Local d'électricité en Région wallonne et l'accès à celui-ci
RTTR	Règlement Technique pour la gestion du réseau de Transport Régional d'électricité en Région de Bruxelles-Capitale
SGU	Significant Grid User
SPGM	Synchronous Power-Generating Modules
TRPV	Technisch Reglement Plaatselijk Vervoernet van Elektriciteit Vlaams Gewest

## 8 References

- [1] 'Network Code Requirements for Generators' or 'NC RfG': Commission Regulation (EU) 2016/631 of 14 April 2016 establishing a network code on requirements for grid connection of generators, <http://eur-lex.europa.eu/legal-content/EN/TXT/PDF/?uri=CELEX:32016R0631&from=EN>
- [2] 'Network Code on Demand Connection' or 'NC DCC': Commission Regulation (EU) 2016/1388 of 17 August 2016 establishing a Network Code on Demand Connection, <http://eur-lex.europa.eu/legal-content/EN/TXT/PDF/?uri=CELEX:32016R1388&from=EN>
- [3] 'Network Code on High Voltage Direct Current' or 'NC HVDC': Commission Regulation (EU) 2016/1447 of 26 August 2016 establishing a network code on requirements for grid connection of high voltage direct current systems and direct current-connected power park modules, <http://eur-lex.europa.eu/legal-content/EN/TXT/PDF/?uri=CELEX:32016R1447&from=EN>
- [4] Federaal Technisch Reglement-22 APRIL 2019. — Koninklijk besluit houdende een technisch reglement voor het beheer van het transmissienet van elektriciteit en de toegang ertoe, Arrêté royal établissant un règlement technique pour la gestion du réseau de transport de l'électricité et l'accès à celui-ci, [www.elia.be/~media/files/Elia/publications-2/grid-codes/20190422\\_FTR-beeld.pdf](http://www.elia.be/~media/files/Elia/publications-2/grid-codes/20190422_FTR-beeld.pdf)
- [5] Presentation FOD/SPF Energy in WG Belgian Grid (in Dutch): [http://www.elia.be/~media/files/Elia/users-group/WG%20Belgian%20Grid/20170307%20WG%20Belgian%20Grid/FOD\\_Vision-for\\_FederalGridCode.pdf](http://www.elia.be/~media/files/Elia/users-group/WG%20Belgian%20Grid/20170307%20WG%20Belgian%20Grid/FOD_Vision-for_FederalGridCode.pdf)
- [6] ENTSO-E Guidance document for national implementation for network codes on grid connection : Parameters of Non-exhaustive requirements, 16 November 2016: [https://www.entsoe.eu/Documents/Network%20codes%20documents/NC%](https://www.entsoe.eu/Documents/Network%20codes%20documents/NC%20)

[7] Règlement Technique pour la gestion du réseau de transport local d'électricité en Région wallonne et l'accès à celui-ci.

<https://wallex.wallonie.be/index.php?doc=21817&rev=22854-14724>

[8] Technisch Reglement Plaatselijk Vervoernet van Elektriciteit Vlaams Gewest.

[https://www.vreg.be/sites/default/files/uploads/technisch\\_reglement\\_plaatselijk\\_vervoernet\\_van\\_elektriciteit.pdf](https://www.vreg.be/sites/default/files/uploads/technisch_reglement_plaatselijk_vervoernet_van_elektriciteit.pdf)

[9] Règlement technique pour la gestion du réseau de transport régional dans la Région de Bruxelles-Capitale"

<https://www.brugel.brussels/actualites/arrete-du-gouvernement-de-la-region-de-bruxelles-capitale-approuvant-le-reglement-technique-pour-la-gestion-du-reseau-de-transport-regional-d-electricite-106>

[10] 'System Operation Guideline' or 'SO GL': Commission Regulation (EU) 2017/1485 of 2 August 2017 establishing a guideline on electricity transmission system operation, <http://eur-lex.europa.eu/legal-content/EN/TXT/PDF/?uri=CELEX:32017R1485&from=EN>

## 9 Appendix I – Definition FRT profile (extract from Art. 14.3 RfG[1])

