

## DESIGN NOTE

# Balancing Services: mFRR

The design for manual Frequency Restoration Reserves (mFRR) in the ELIA LFC Block in the framework of the European platform for mFRR Energy exchanges (MARI project).

Document Version: July 2023



## A. VERSION HISTORY

Version	Date	Additional information (purpose, main changes, ...)
1	December 2020	1 <sup>st</sup> version of the design note with the review of the mFRR Service Shared externally for informal consultation (16/12/2020 – 5/2/2021)
2	June 2021	Design fine tuning, completion of chapters
3	January 2022	Design fine tuning, completion of few chapters, corrections of typos and small text improvements
4	July 2023	Finalization of the design for the MARI project, corrections of typos and small text improvements

## B. CONTENT

A.	Version history .....	2
B.	Content .....	3
C.	Introduction .....	6
D.	mFRR Service explanatory note .....	8
1.	Purpose and use of mFRR .....	8
1.1.	How ELIA uses mFRR .....	8
1.1.1.	mFRR for Balancing .....	8
1.1.2.	mFRR for congestion management .....	10
1.2.	How the mFRR-Platform changes the use of mFRR for ELIA .....	10
1.3.	How the mFRR-Platform changes opportunities for Belgian BSPs .....	12
2.	mFRR Products .....	14
2.1.	mFRR Capacity Product .....	14
2.2.	mFRR energy product .....	15
3.	Participation to the mFRR Service .....	18
3.1.	mFRR Capacity Product .....	18
3.2.	mFRR energy product .....	18
3.2.1.	Mandatory provision of mFRR Energy Bids .....	19
3.2.2.	Voluntary provision of mFRR Energy Bids .....	19
3.3.	Delivery Points and mFRR Providing Groups .....	19
3.4.	Combinability rules .....	20
4.	Balancing Service Provider (BSP) .....	22
4.1.	Qualification as BSP for mFRR .....	22
4.2.	Interdependencies with other parties .....	22
4.2.1.	Impact of mFRR on the BRP .....	23
4.2.2.	Impact of mFRR on the Scheduling Agent .....	25
5.	Tests prior to participation to the mFRR Service .....	26
5.1.	Communication test .....	26
5.2.	Prequalification test .....	26
5.2.1.	Organization of a prequalification test .....	27
5.2.2.	Specifications of a prequalification test .....	27
5.2.3.	Outcomes of a prequalification test .....	28
5.2.4.	Possible modifications of the mFRR <sub>max</sub> .....	28
5.2.5.	Modalities to modify the Baseline of a DP <sub>PG</sub> .....	28
6.	Capacity procurement .....	29
6.1.	Procurement of mFRR capacity .....	29
6.2.	Transfers of mFRR capacity .....	30
7.	Submission of mFRR Energy Bids .....	31

7.1.	Submission of mFRR Energy Bids to ELIA.....	31
7.1.1.	Timeline for energy bid submission.....	31
7.1.2.	Characteristics of mFRR Energy Bids set by the BSP.....	32
7.2.	Supporting mFRR Providing Group.....	45
7.3.	Baseline for activation.....	45
7.4.	Update of mFRR Energy Bid by the BSP after BE GCT.....	46
7.5.	Bids modification by ELIA.....	48
7.5.1.	Avoiding mFRR activation due to internal congestion risks.....	49
7.5.2.	Avoiding double activation.....	52
7.5.3.	Guaranteed Volume.....	52
7.5.4.	Avoiding erroneous activation.....	53
8.	Selection of mFRR Energy Bids for balancing purposes.....	54
8.1.	ELIA preprocessing of mFRR Energy Bids when connected to the mFRR-Platform.....	54
8.2.	Fallback procedure.....	55
8.3.	Local selection of mFRR Energy Bids for balancing purposes.....	55
8.3.1.	Preprocessing.....	55
8.3.2.	Local Merit Order List creation.....	55
8.3.3.	Local selection of bids.....	56
9.	Activation of mFRR Energy Bids.....	58
9.1.	mFRR requested.....	58
9.2.	BSP response.....	58
9.3.	Use of DP in response to an activation request.....	59
9.4.	Multiple activations on a Delivery Point part of a same Providing Group.....	61
9.4.1.	Multiple activations during the same quarter-hour.....	61
9.4.2.	Multiple activations during consecutive quarter-hours.....	63
10.	Remuneration.....	64
10.1.	Remuneration of mFRR Awarded.....	64
10.2.	Remuneration of mFRR Requested.....	64
10.2.1.	Applicable price.....	65
10.2.2.	mFRR energy requested.....	67
11.	Controls.....	69
11.1.	Availability controls.....	69
11.1.1.	Control of the mFRR Made Available.....	69
11.1.2.	Availability test.....	70
11.2.	Activation control.....	71
11.2.1.	Activation control of mFRR Energy bid.....	71
11.2.2.	Activation control for Combo mFRR-Redispatching on the same DP.....	75
12.	Penalties.....	78

12.1.	Penalties for MW (not) Made Available.....	78
12.2.	Penalties for mFRR Missing MW.....	79
12.3.	Penalties for mFRR Energy Missing.....	80
12.4.	Cap on financial penalties.....	81
13.	Local use of mFRR for congestion management purpose.....	82
13.1.	Local selection and activation.....	82
13.2.	Settlement.....	83
13.3.	Impact on the BRP perimeter.....	84
E.	List of useful references.....	85

## C. INTRODUCTION

As part of managing the electricity system, ELIA ensures the balance of the grid. Specifically, ELIA uses Balancing Services procured from **Balancing Service Providers (BSPs)** to manage the imbalances between electricity production and consumption. The imbalances can occur when **Balance Responsible Parties (BRPs)**<sup>1</sup> are not able to balance the offtake and the injection within their customer portfolios or when ELIA activates energy for other purposes than balancing.

ELIA procures three types of Balancing Services from BSPs:

- Frequency Containment Reserves (FCR);
- automatic Frequency Restoration Reserves (aFRR);
- manual Frequency Restoration Reserves (mFRR).

**This design note** concerns the **manual Frequency Restoration Reserves (mFRR)**. BSPs provide mFRR Service to ELIA in accordance with the **BSP Contract mFRR, part of the Terms and Conditions** for Balancing Service Providers for manual Frequency Restoration Reserve (hereafter referred to as **T&C BSP mFRR**)<sup>2</sup>.

### Document version – July 2023

Currently ELIA procures the mFRR service locally<sup>3</sup>. In accordance the Regulation 2017/2195 establishing a guideline on electricity balancing (EBGL), all European TSOs must develop a **European platform for mFRR energy** (i.e., the “MARI Platform” or the “mFRR-Platform”).

The connection to the mFRR Platform requires a thorough review of the service design to ensure that the local and European levels are well matched. **This design note explains the design changes of the Belgian mFRR Service that are required in order to prepare the connection to the European mFRR-Platform.**

The new processes were first described in a design note published and consulted between December 2020 and February 2021. Afterwards, open design points were further investigated and discussed between Elia and the various stakeholders. The final status of the future mFRR design is included in the present version of the design note.

### Indicative timeline

In accordance with the roadmap drawn up in consultation with the Balancing WG of Elia's Users' Group, the implementation of the service changes made for ELIA's connection to the mFRR-Platform has been divided into two steps:

- **Step 1** (planned for Q1 2024): This step concerns the Local Go Live of service changes. The changes result mainly from the alignment of the mFRR Service with the standard energy product as defined by European regulations. This includes the generalization of the explicit bidding of mFRR energy, new timings for the submission and activation of bids, and new activation profiles.
- **Step 2** (planned for Q2 2024): This step involves the connection to the mFRR-Platform<sup>4</sup>. This connection affects the selection of mFRR Energy Bids and the determination of the price for activated mFRR energy. It makes it possible to activate bids abroad to meet ELIA's mFRR needs, and to activate bids in Belgium to meet all European TSOs' mFRR needs. The remuneration of activated bids is then determined by mFRR-Platform.

---

<sup>1</sup> For more information, visit <https://www.ELIA.be/en/electricity-market-and-system/role-of-brp>

<sup>2</sup> Available online: <https://www.ELIA.be/en/electricity-market-and-system/system-services/keeping-the-balance/mfrr>

<sup>3</sup> ELIA has also bilateral agreements with surrounding TSOs for reserve sharing.

<sup>4</sup> ELIA will in advance already connect for end-to-end testing.

The design explained in this note will be integrated in the technical guides of the IT applications and in a proposal for amendment by ELIA of the regulated documents (i.e., the T&C BSP mFRR and the Balancing Rules).

## Contractual Framework

<b>EBGL</b>
<p><b>Article 5(4).</b> The proposals for the following terms and conditions or methodologies shall be subject to approval by each regulatory authority of each concerned Member State on a case-by-case basis: [...] (c) the terms and conditions related to balancing pursuant to Article 18.</p> <p><b>Article 18(1).</b> No later than six months after entry into force of this Regulation and for all scheduling areas of a Member State, the TSOs of this Member State shall develop a proposal regarding:</p> <p>(a) the terms and conditions for BSPs; [...]</p> <p>[Article 18(4) and (5) contain rules on the content of the terms and conditions for BSPs]</p>
<b>Federal Grid Code</b>
<p><b>Article 225.</b> De aanbieder van balanceringsdiensten stelt aan de transmissienetbeheerder aanbiedingen van balanceringsenergie ter beschikking overeenkomstig aan de modaliteiten en voorwaarden van toepassing op de aanbieders van balanceringsdiensten. Die modaliteiten en voorwaarden van toepassing op de aanbieders van balanceringsdiensten worden bepaald door de transmissienetbeheerder krachtens artikel 18.1 en 18.5 van de Europese richtsnoeren EBGL en voor goedkeuring voorgelegd aan de commissie overeenkomstig artikel 5.4 van de Europese richtsnoeren EBGL en de artikelen 4, 5 en 6 van dit besluit. [...]. De aanbieder van balanceringsdiensten sluit met de transmissienetbeheerder één of meerdere overeenkomsten voor balanceringsdiensten af waarin hij zich ertoe verbindt om de modaliteiten en voorwaarden van toepassing op aanbieders van balanceringsdiensten na te leven. Deze overeenkomsten worden eveneens ter goedkeuring voorgelegd aan de commissie. / Le fournisseur de services d'équilibrage soumet au gestionnaire de réseau de transport des offres d'énergie d'équilibrage conformément aux modalités et conditions applicables aux fournisseurs de services d'équilibrage. Ces modalités et conditions applicables aux fournisseurs de service d'équilibrage sont déterminées par le gestionnaire de réseau de transport en vertu de l'article 18.1 et 18.5 de la ligne directrice européenne EBGL et soumises à la commission pour approbation conformément à l'article 5.4 de la ligne directrice européenne EBGL et aux articles 4, 5 et 6 du présent arrêté. [...] Le fournisseur de services d'équilibrage conclut un ou plusieurs contrats de services d'équilibrage avec le gestionnaire de réseau de transport dans le(s)quel(s) il s'engage à respecter les modalités et conditions applicables aux fournisseurs de services d'équilibrage. Ces contrats sont également soumis à la commission pour approbation.</p>

The design for the mFRR Service is formalized in the **BSP Contract mFRR**, which is part of the Terms and Conditions for BSPs for manual Frequency Restoration Reserve (i.e., the **T&C BSP mFRR**), in accordance with the EBGL, the Code of Conduct and the Federal Grid Code. The current T&C BSP mFRR entered into force on February 3<sup>rd</sup>, 2020, and will need to be amended to reflect the new future design as described in this design note. ELIA will propose an amendment of the T&C BSP mFRR after public consultation. In parallel the new design will require updates to some other regulated documents (e.g., the Balancing Rules<sup>5</sup> and the LFC Block Operational Agreement<sup>6</sup>).

<sup>5</sup> The Balancing Rules are subject to a public consultation until August 30, 2023. The document subject to the public consultation can be found here: [elia.be/fr/consultations-publiques/20230705\\_public-consultation-on-the-tandc-bsp-mfrr-in-the-framework-of-the-mari](https://elia.be/fr/consultations-publiques/20230705_public-consultation-on-the-tandc-bsp-mfrr-in-the-framework-of-the-mari)  
<sup>6</sup> Both documents are available on the ELIA web site via: <https://www.ELIA.be/en/electricity-market-and-system/system-services/keeping-the-balance>.

## D. MFRR SERVICE EXPLANATORY NOTE

### 1. Purpose and use of mFRR

The use of mFRR is part of the frequency restoration process which serves to “regulate the Frequency Restoration Control Error (FRCE) towards zero within the time to restore frequency” in accordance with articles 143 and 145 of the SOGL. The **mFRR Service** includes the procurement of **mFRR Balancing Capacity** as well as the activation of **mFRR Energy Bids**.

Since February 2020, **ELIA procures mFRR Balancing Capacity on a daily basis**. The amount of mFRR Capacity to procure for day D (for each of the 6 blocks of 4 hours<sup>7</sup> of day D) is also determined daily based on dynamic dimensioning in line with the LFC Block Operational Agreement (LFC BOA) and the LFC Means<sup>8</sup>.

**Closer to real-time, ELIA activates mFRR Energy Bid**, either provided by the BSPs to comply with the obligations of the previously procured mFRR Capacity or offered by BSPs on a voluntary basis (i.e., “free bids”).

Starting from 2023, the activation of most of the Belgian mFRR Energy Bids will be organized on a European level via the mFRR-Platform, which serves to facilitate the integration of the European balancing energy markets<sup>9</sup>. In accordance with article 11(3) of the mFRR Implementation Framework (i.e., the “mFRR IF”), the activation optimization function of the mFRR-Platform (i.e., the “mFRR AOF”) aims firstly to “maximize the economic surplus” when selecting the standard mFRR energy bids to cover the mFRR energy needs of the Participating TSOs while secondly “minimizing the number of exchanges on each mFRR balancing border”.

From ELIA’s connection on:

- The mFRR-Platform will provide ELIA the opportunity to cover its mFRR demands in the most efficient manner depending on the availability and price of mFRR energy bids in Belgium as well as in surrounding countries and depending on the available cross-border capacities for exchanges of mFRR Energy.
- The mFRR-Platform will provide Belgian BSPs the opportunity to gain revenues by selling mFRR Energy Bids to satisfy balancing demands not only in Belgium but also abroad.

#### 1.1. How ELIA uses mFRR

ELIA can use mFRR for two purposes:

1. Balancing
2. Congestion management

##### 1.1.1. mFRR for Balancing

The main purpose of mFRR is for balancing: to restore the frequency and balance the system together with FCR and aFRR. ELIA can decide to activate mFRR Energy Bids either:

- in quasi real-time (in response to the occurring ACE) – as per section 1.1.1.1; or

---

<sup>7</sup> ELIA procures mFRR Capacity for each of six Capacity Contracting Time Units (CCTU) of day D: In accordance with the BSP Contract mFRR, a CCTU is a period of 4 hours for which the mFRR Capacity Bids offered by the BSP to ELIA can be activated as mFRR Energy Bids. A single capacity auction (on day D-1) is performed per CCTU.

<sup>8</sup> Available online: <https://www.ELIA.be/en/electricity-market-and-system/system-services/keeping-the-balance>

<sup>9</sup> Note that the mFRR-Platform concerns the exchange of mFRR energy only. The procurement of mFRR Capacity either nationally or via cross-border procurement is not in scope of the mFRR-Platform.



- pro-actively (if ELIA has requested non-balancing activations that will affect the ACE) – as per section 1.1.1.2. The selection and settlement of the activated mFRR follow the design explained throughout this note.

**1.1.1.1. mFRR activation based on real-time observations**

ELIA uses mFRR to keep the ACE within an acceptable range and/or to relieve aFRR. This is usually decided based on real-time observations of the Belgian imbalance. As explained in section 1.2, ELIA will decide in quarter-hour QH<sub>1</sub> or in quarter-hour QH<sub>0</sub> whether it needs a Scheduled Activation or a Direct Activation of mFRR energy bids to balance the system in QH<sub>0</sub>.

**1.1.1.2. mFRR activation to compensate the impact of non-balancing activations**

When ELIA has requested the activation of active power for non-balancing purposes in QH<sub>0</sub>, then ELIA knows that this will cause a System Imbalance. ELIA will therefore request the activation of mFRR energy bids for the QH<sub>0</sub> proactively in order to counter the impact of the non-balancing activation before actually observing any change in the System Imbalance (knowing that ELIA will not assess or compensate the possible impact of a ramping before or after the period in which the non-balancing activation is requested). This is often referred to as the “**compensation mechanism**”.

Non-balancing activations that would request ELIA to use the compensation mechanism are the followings:

- Redispatching for national congestion management;
- Redispatching as triggered by the LFC BOA exceptional measures (such as the request of a start-up as part of storm risk mitigation);
- mFRR prequalification test;
- mFRR availability test.

If several non-balancing activations are requested in opposing direction, it is possible that they partially or completely compensate each other and therefore reduce ELIA’s need to use the compensation mechanism.

The net resulting compensation needed for QH<sub>0</sub> serves as input for ELIA in the process to determine the need for Scheduled Activation (i.e., SA). This need is equal to the sum of the compensation need (as described in section 1.1.1.2) and the real-time balancing need (as described in 1.1.1.1).

**Example:**

For QH<sub>0</sub> ELIA has requested (or plans to request) the following activations

- At RT-60’ for QH<sub>0</sub> ELIA requests an upward redispatching activation of +100 MW on one technical unit and a downward redispatching activation of -75 MW on another technical unit.
- In QH<sub>0</sub> an mFRR prequalification test is organized with a expected power of +25 MW.
- Net compensation result = -(100 MW - 75 MW + 25 MW) = -50 MW

If, for QH<sub>0</sub>, in addition to the above compensation need:

<b>ELIA has no RT mFRR need</b>	<b>The system is already short and has a RT mFRR need of +150 MW</b>	<b>The system is already long and has a RT mFRR need of - 200 MW</b>
ELIA’s demand for SA = - 50 MW	ELIA’s demand for SA = -50 MW +150 MW =+ 100 MW	ELIA’s demand for SA = -50 MW +(-200 MW) = -250 MW

### 1.1.2. mFRR for congestion management

To solve a specific congestion risk, ELIA may not have any remedial actions at its disposal other than the energy offered by a BSP in an mFRR Energy Bid. In this situation, ELIA will declare this mFRR Energy Bid as unavailable for activation via the mFRR-Platform, but nonetheless activate it locally in respect of the BSP Contract mFRR.

ELIA does not intend to submit mFRR needs for purpose of congestion management to the European mFRR-Platform.

## 1.2. How the mFRR-Platform changes the use of mFRR for ELIA

**Today**, ELIA continuously monitors the System Imbalance to decide whether to activate mFRR Energy Bids. If so, based on the mFRR demand and on the local merit order<sup>10</sup> of mFRR Energy Bids, ELIA requests the BSP(s) to activate its mFRR Energy Bids, either via a Scheduled Activation (as defined in section 2.2) or a Direct Activation (as defined in section 2.2).

**In the future**, ELIA will have to submit both the mFRR demand and the mFRR Energy Bids to the mFRR-Platform. Based on the mFRR demands and on the mFRR energy bids submitted by all TSOs (as well as information on cross-border capacities), the mFRR-Platform will determine which mFRR energy bids are to be activated in each TSOs' LFC Block. To ensure an efficient and effective functioning of the mFRR-Platform, TSOs will be **bound by strict timings** to submit the required information. **Scheduled Activation and Direct Activations will be possible but defined differently** than in the Belgian mFRR design applicable today.

As visualized in Figure 1:

- **RT**: The real-time point that serves as a reference for the other timings is the start of the concerned QH<sub>0</sub>.
- **RT-25'**: The **Balancing Energy Gate Closure Time (BE GCT) for mFRR Energy Bids** is 25 minutes before the start of the concerned QH<sub>0</sub>. This means that BSPs must have submitted all their mFRR Energy Bids to their Participating TSO at the latest by this deadline. At RT-25', mFRR Energy Bids are considered as firm and can no longer be modified by the BSP<sup>11</sup>.
- **RT-12'**: Each **TSO must share the mFRR Energy Bids** received from the BSPs with the mFRR-Platform at the latest by 12 minutes before the start of the concerned QH<sub>0</sub>. Afterwards, changes in the availability status or volume of transmitted mFRR Energy Bids remain possible but might not be taken into account by the mFRR-Platform, depending on the running optimization for QH<sub>0</sub> at that time.
- **RT-10'**: If a TSO has an **mFRR demand for Scheduled Activations** for QH<sub>0</sub> then the TSO must submit it to the mFRR-Platform at the latest by 10 minutes before QH<sub>0</sub>. After this point in time, the mFRR-Platform will start the optimization for Scheduled Activations and no new information can be taken into consideration.
- **Between RT-10' and RT+5'**: Any **mFRR demand** for QH<sub>0</sub> submitted by a TSO after RT-10' is considered as a demand for **Direct Activation**. TSOs may request Direct Activations for QH<sub>0</sub> until 5 minutes after the start of QH<sub>0</sub>.

<sup>10</sup> Note that the local mFRR merit order takes into account economic as well as technical characteristics of the mFRR Energy Bids, as foreseen in the Balancing Rules.

<sup>11</sup> With the exception of some rules for reduction of bid volume explained in section 7.4.

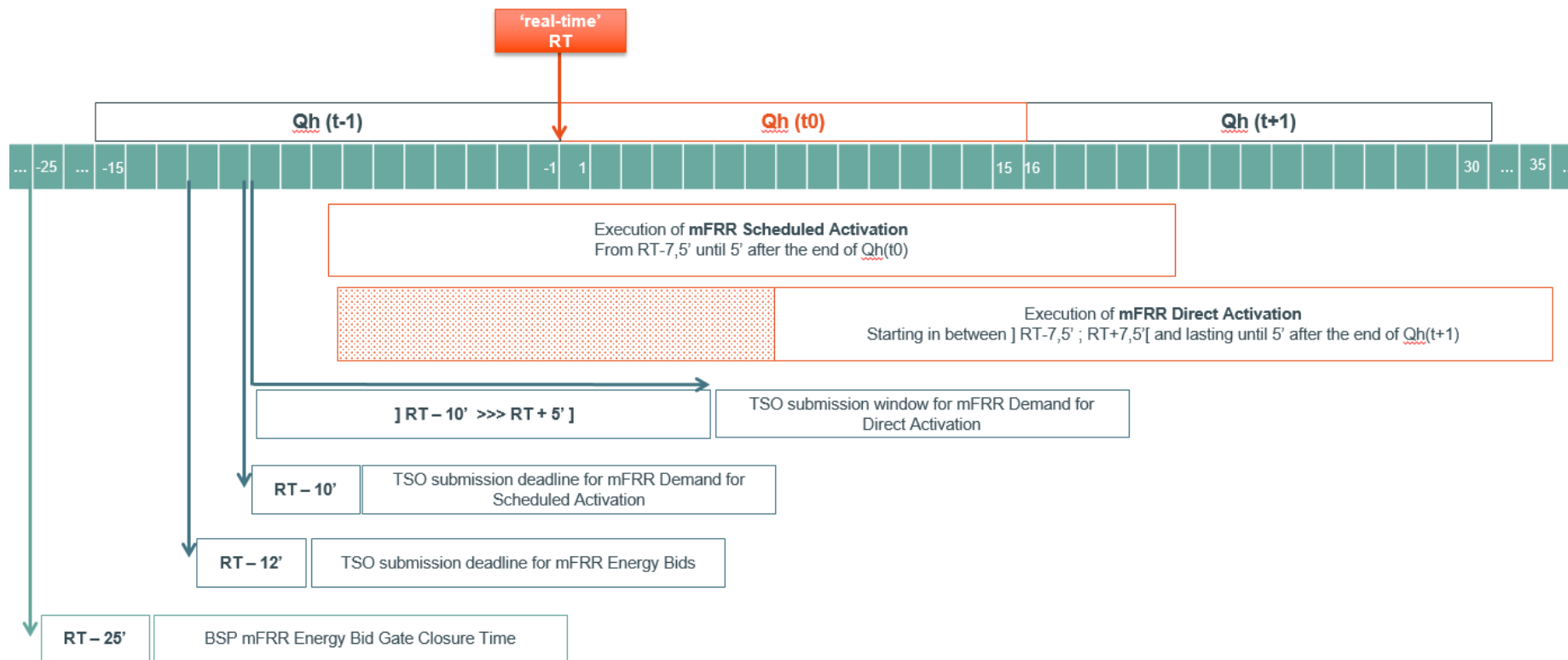

Figure 1: mFRR-Platform timings for quarter-hour  $QH(t0)$

The optimization algorithm of the mFRR-Platform searches for a solution that maximizes economic surplus. If several possible solutions are found, the criterion to minimize the use of cross-border capacity for mFRR energy exchanges is also taken into account. The result of the mFRR-Platform may lead to the following **situations in terms of ELIA mFRR demand and selection of Belgian mFRR Energy Bids** (as depicted in Table 1):

- The ELIA LFC Block has an mFRR demand (submitted to the mFRR-Platform) that is fully covered by the activation of mFRR Energy Bids in the ELIA LFC Block. **(Case 1)**
- The ELIA LFC Block has an mFRR demand (submitted to the mFRR-Platform) that is covered by the activation of mFRR Energy Bids in the ELIA LFC Block as well as by the activation of mFRR energy bids in other TSOs' LFC blocks or partially netted with demands of other TSOs. Consequently, there is a cross-border exchange of mFRR energy. **(Case 1)**
- The ELIA LFC Block has an mFRR demand (submitted to the mFRR-Platform) that is fully covered by the activation of mFRR energy bids in other TSOs' LFC blocks or fully netted with demands of other TSOs. Consequently, there is a cross-border exchange. **(Case 4)**
- The ELIA LFC Block has an mFRR demand (submitted to the mFRR-Platform) and the mFRR Energy Bids in the ELIA LFC Block, going in the other direction than the one for ELIA's mFRR Demand, are selected for activation to cover the demand of other TSOs. **(Cases 2 and 3)** There could be situations where activations in the ELIA LFC block could happen in both directions. **(Case 2)**
- The ELIA LFC Block does not have an mFRR demand, yet the mFRR-Platform selects mFRR Energy Bids in the ELIA LFC Block for activation in one or both directions to cover the demand of other TSOs. Consequently, there is a cross-border exchange of mFRR Energy. **(Cases 5 and 6)**
- The ELIA LFC Block does not have an mFRR demand and the mFRR-Platform does not select mFRR Energy Bids in the ELIA LFC Block for activation. **(Case 7)**

Case	ELIA mFRR Demand	mFRR Energy Bids in ELIA LFC Block activated in <b>same direction as ELIA's mFRR Demand</b>	mFRR Energy Bids in ELIA LFC Block activated in the <b>opposite direction to ELIA's mFRR Demand</b>	Cross-border exchanges
1	Yes	Yes	/	Possible
2	Yes	Yes	Yes	Yes
3	Yes	/	Yes	Yes
4	Yes	/	/	Yes
5	/	Yes	Yes	Yes
6	/	Yes	/	Yes
7	/	/	/	No

Table 1: Possible scenarios between ELIA's mFRR Demand and activation of mFRR Energy Bids in ELIA LFC Block

As depicted in the scenarios of Table 1, it is possible that mFRR Energy Bids in the ELIA LFC Block are requested for activation in the other direction than the Belgian System Imbalance.

### 1.3. How the mFRR-Platform changes opportunities for Belgian BSPs

The contracting of mFRR remains a national matter: A BSP can only offer mFRR Energy Bids to the TSO to which it is connected, while respecting the contract signed with its respective TSO. Therefore, in Belgium, BSPs offer the mFRR Service only to ELIA, while respecting the BSP Contract mFRR (as approved by the CREG).

What changes is that ELIA will share those mFRR Energy Bids with the mFRR-Platform and a BSP may be activated because its mFRR Energy Bid is selected due to the mFRR demand of ELIA or any other Participating TSO (see Figure 2). Although the contract remains between the BSP and ELIA (and not another European counterpart), the contract nonetheless needs to be updated to reflect the impact of the added European layer.

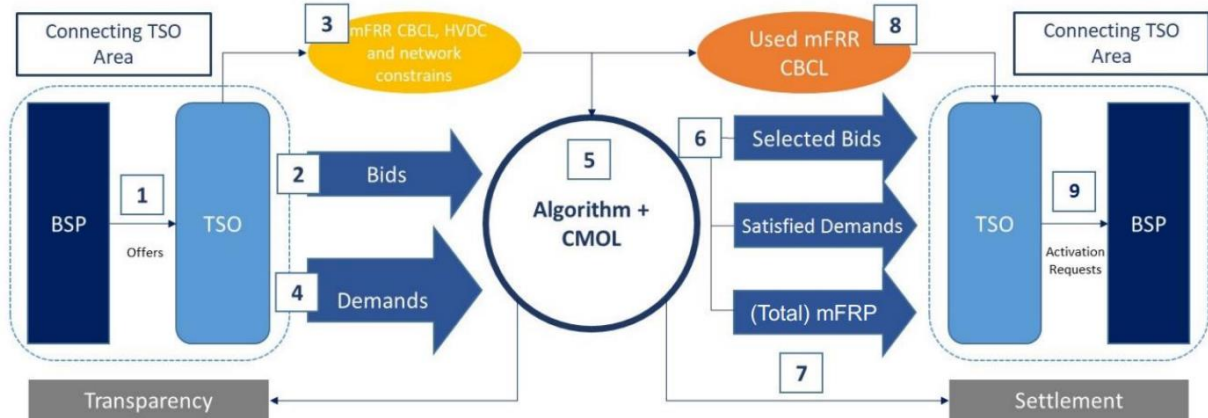

Figure 2: Overview of BSP-TSO and TSO-mFRR-Platform flows<sup>12</sup>

<sup>12</sup> Source: Figure 4 in the “Explanatory document to all TSOs’ proposal for the implementation framework for a European platform for the exchange of balancing energy from frequency restoration reserves with manual activation in accordance with Article 20 of Commission Regulation (EU) 2017/2195 establishing a guideline on electricity balancing” of 18 December 2018.

## 2. mFRR Products

The mFRR Service includes two types of product:

- **mFRR Capacity product:** TSOs procure mFRR Balancing Capacity in advance of day D resulting in an obligation for BSPs to submit mFRR Energy Bids for the concerned contracted period on day D.
- **mFRR Energy product:** BSPs offer mFRR Energy Bids for activation during day D, either on a free basis or following procurement of mFRR Capacity Product.

The **European regulation** (EBGL, mFRR IF, SPBC<sup>13</sup>...) has defined **standard mFRR balancing products for both energy and capacity**. TSOs must use the standard products to connect to the mFRR-Platform. The use of specific products is allowed, but only if justified and approved by the regulator.

Currently ELIA has two mFRR Capacity Products: mFRR Standard and mFRR Flex. As communicated in the Working Group balancing of September 15<sup>th</sup>, 2021, ELIA confirmed the phase-out of mFRR Flex from the mFRR Technical Go-Live<sup>14</sup>. This design note therefore focuses on the future mFRR design for standard products only.

Thereby the evolution of ELIA's mFRR products is as follows:

AS-IS design	TO BE design
Upward mFRR	Upward mFRR
mFRR non-contracted (energy only)	mFRR Capacity Product
mFRR Standard (capacity + energy)	mFRR energy product
mFRR Flex (capacity + energy)	
Downward mFRR	Downward mFRR
mFRR non-contracted (energy only)	mFRR energy product

Figure 3. Evolution of ELIA's mFRR products

### 2.1. mFRR Capacity Product

According to the annex 1 of the SPBC, ELIA's mFRR Capacity Product already complies with the rules for standard products for mFRR Capacity. ELIA procures mFRR Balancing Capacity per validity period<sup>15</sup> of 4 hours, without neutralization time between two activations.

The upward (positive) and downward (negative) mFRR Balancing Capacity to procure daily is determined based on a dynamic dimensioning of balancing needs and means (in accordance with the LFC BOA and the LFC Means). The results are published on the ELIA website<sup>16</sup>. Following the methodology for dimensioning balancing capacity, ELIA procures mFRR Balancing Capacity for upward activations but no volumes for downward activations.

<sup>13</sup> The SPBC refers to the "Methodology for a list of standard products for balancing capacity for frequency restoration reserves and replacement reserves in accordance with Article 25(2) of Commission Regulation (EU) 2017/2195 of 23 November 2017 establishing a guideline on electricity balancing" as approved by all regulating authorities on 17 June 2020.

<sup>14</sup> The mFRR Technical Go-Live is the moment of entry into force of the BSP Contract mFRR developed in the context of the accession of ELIA to the mFRR-Platform.

<sup>15</sup> The "validity period" of the SPBC corresponds to the "Capacity Contracting Time Unit" (or CCTU) defined in the T&C BSP mFRR.

<sup>16</sup> Visit <https://www.ELIA.be/en/grid-data/balancing/capacity-volumes-needs>

## 2.2. mFRR energy product

### Attention point in comparison to current design

- In the current design, the Full Activation Time is 15'.
- Scheduled Activation and Direct Activations exist but are defined differently than in the new European regulation. In the current design:
  - A Scheduled Activation is the activation of a mFRR Energy Bid requested by ELIA for which the start of the activation is the beginning of the next quarter-hour;
  - A Direct Activation is the activation of a mFRR Energy Bid for which the request is sent by ELIA 3 minutes before the beginning of the concerned activation.

### mFRR IF definitions – Article 2

(s) '**mFRR market time unit**' (hereafter "**mFRR MTU**") means a period of **15 minutes** length. The first mFRR MTU starts at 00:00 market time. The mFRR MTUs shall be consecutive and not overlapping;

(v) '**Point of Scheduled Activation**' means the point in time from which Full Activation Time is measured for the Scheduled Activation and is 7.5 minutes before beginning of the quarter-hour for which the BSPs place the respective standard mFRR balancing energy product bid. The BSP receives activation request 12.5 minutes before expected full activation;

### EBGL definitions – Article 2

(29) '**preparation period**' means the period between the request by the connecting TSO in case of TSO-TSO model or by the contracting TSO in case of TSO-BSP model and the start of the ramping period;

(30) '**Full Activation Time**' means the period between the activation request by the connecting TSO in case of TSO-TSO model or by the contracting TSO in case of TSO-BSP model and the corresponding full delivery of the concerned product;

(31) '**deactivation period**' means the period for ramping from full delivery to a set point, or from full withdrawal back to a set point;

(32) '**delivery period**' means the period of delivery during which the BSP delivers the full requested change of power in-feed to, or the full requested change of withdrawals from the system;

### mFRR IF definitions – Article 7

1. Each standard mFRR balancing energy product bid shall fulfil the following static characteristics:

- [...]
- Activation Type: Direct of scheduled
- Full Activation Time ("FAT"): **12.5 minutes**
- Minimum duration of delivery period: 5 minutes
- Validity Period:
  - A scheduled Activation can take place at the Point of Scheduled Activation only.
  - A Direct Activation can take place at any time during the 15 minutes after the Point of Scheduled Activation.

2. The delivery of a direct activatable bid shall include the mFRR MTU following the one the bid refers to.

In accordance with the mFRR IF and the EBGL, mFRR Energy Bids must comply with the following characteristics:

- The **Full Activation Time (“FAT”)** equals **12.5 minutes**. The FAT is the period between the activation request sent by ELIA to the BSP and the corresponding full delivery. As agreed in the MARI project for the TSO-TSO exchanges during this Full Activation Time, this 12.5-minute period includes:
  - the preparation period of 2.5 minutes, i.e., the period between the activation request sent by ELIA to the BSP and the start of the ramping period;
  - the period of 10 minutes for linear ramping up to the point of full delivery.
- The minimum duration of the **delivery period** is **5 minutes**. During the delivery period, the BSP delivers the full requested change of power (in positive or negative direction).
- After the full delivery, there is a **deactivation period** (i.e., the ramping period) during which the power level returns to the level of the set point (i.e., the Baseline). A more concrete deactivation period of 10 minutes has been decided on in the MARI project for the TSO-TSO exchanges.
- mFRR activations that follow the profile described above, have an impact during at least 27.5 minutes.
- mFRR Energy Bids (if confirmed in the bid characteristics) can be activated either:
  - in **Scheduled Activation (“SA”)** – see Figure 4):

The preparation period of a SA starts 7.5 minutes before the beginning of the quarter-hour for which the BSP has submitted the bid (i.e., “the Point of Scheduled Activation”) and the deactivation period ends 5 minutes after the end of this quarter-hour.

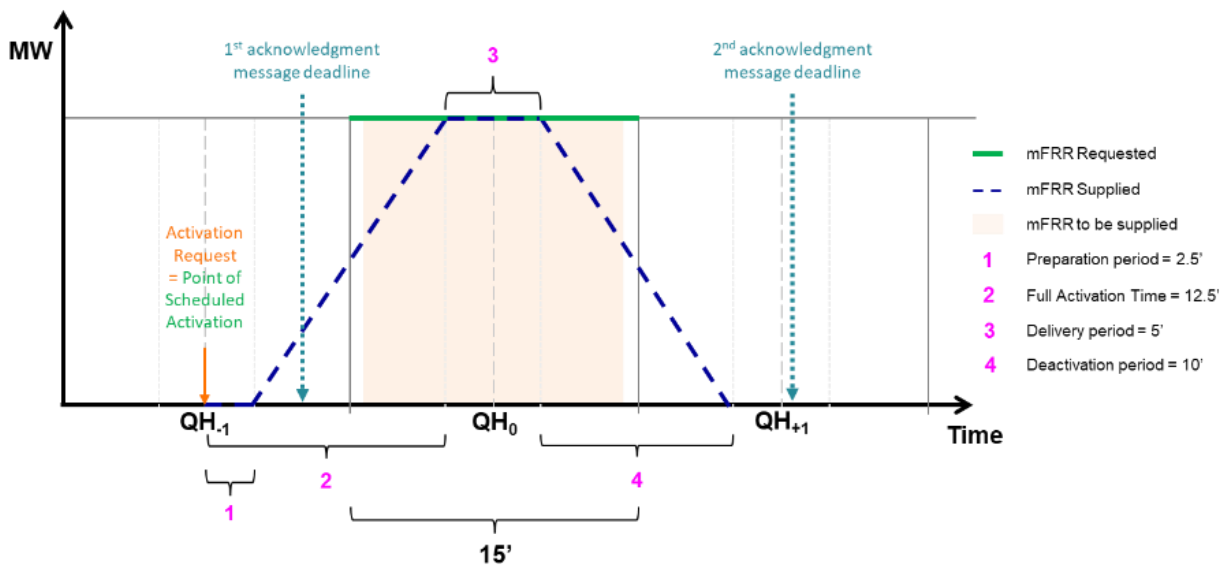

Figure 4. Scheduled Activation profile

- in **Direct Activation (“DA”)** – see Figure 5):

A DA can be requested to the BSP at any moment within the 15 minutes after the Point of Scheduled Activation of the quarter-hour for which the BSP has submitted the bid. The delivery continues into the consecutive quarter-hour and the deactivation period (i.e., the ramping period) ends 5 minutes after the end the quarter-hour consecutive to the one for which the BSP has submitted the bid. Therefore, a DA lasts between 27.5 and 42.5 minutes (incl. preparation and ramping).



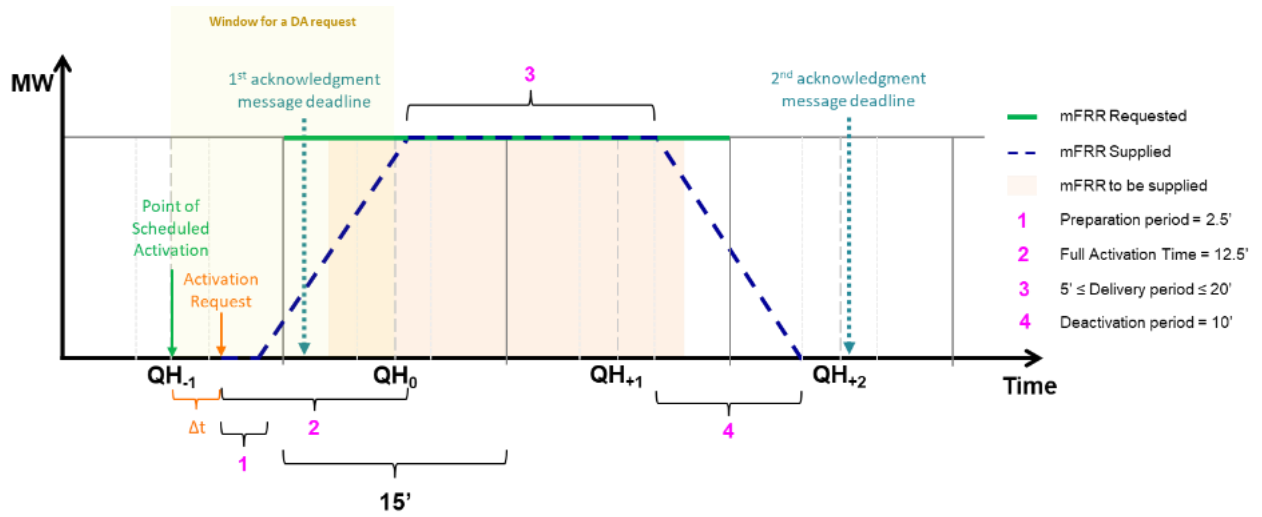

Figure 5. Direct Activation: timings and TSO-TSO profile

## 3. Participation to the mFRR Service

BSPs can provide mFRR Capacity and mFRR Energy to ELIA. The rules for participation to both markets are explained in the following sections.

Code of Conduct
<p><b>Art. 242.</b> Tot de datum van inwerkingtreding van de eerstvolgende wijziging van de betrokken type-overeenkomst(en) voor balanceringsdiensten waarin al dan niet eisen worden bepaald met toepassing van artikel 18.7, b) of c), van de Europese richtsnoeren EBGL, dient het beschikbare opwaartse of neerwaartse actieve vermogen te worden aangeboden door een aanbieder van balanceringsdiensten, aangesteld overeenkomstig artikel 218, onder de vorm van aanbiedingen van balanceringsenergie aan de transmissienetbeheerder voor: 1° elke elektriciteitsproductie-eenheid waarvan het maximaal vermogen groter is dan of gelijk is aan 25 MW; 2° elke energieopslagfaciliteit, van het type C of D overeenkomstig de maximumcapaciteitsdrempelwaarden in het technisch reglement. / Jusqu'à la date d'entrée en vigueur de la prochaine modification du ou des contrats types pertinents pour les services d'équilibrage où des exigences sont définies ou non en application de l'article 18.7, b) ou c) de la ligne directrice européenne EBGL, la puissance active disponible à la hausse ou à la baisse doit être proposée par un fournisseur de services d'équilibrage nommé conformément à l'article 218 sous la forme d'offres d'énergie d'équilibrage au gestionnaire du réseau de transport pour : 1° chaque unité de production d'électricité dont la puissance maximale est supérieure ou égale à 25 MW ; 2° chaque installation de stockage d'énergie de type C ou D, conformément aux seuils de puissance maximale du règlement technique.</p>

### 3.1. mFRR Capacity Product

ELIA publishes the mFRR Balancing Capacities demand for every day D early in the morning of day D-1. Therefore, BSPs are informed of the demand ahead of the mFRR Capacity Gate Closure Time.

To offer mFRR Capacity Bids, the BSP must in advance have prequalified Delivery Point(s) (see section 5.2 on the prequalification test). Chapter 6 describes the procurement of mFRR Balancing Capacities by ELIA.

### 3.2. mFRR energy product

A BSP must at least offer mFRR Energy Bid(s) to ELIA to comply with its mFRR Obligations (i.e., the sum of mFRR Awarded and Accepted Transfers of Obligation of the mFRR Service). In addition, a BSP can offer remaining available active power as mFRR Energy Bids (i.e., “free bids”), either on:

- on a **mandatory** basis depending on its obligations resulting from the rules of the Code of Conduct (as per section 3.2.1); or
- a **voluntary** basis (as per section 3.2.2).

A BSP offers **mFRR Energy Bids in accordance with the mFRR requirements**, outlined in the BSP Contract mFRR. This contract must be signed by the BSP in order to be able to deliver the mFRR Service.

### 3.2.1. Mandatory provision of mFRR Energy Bids

#### 3.2.1.1. mFRR Obligation

From the mFRR Capacity GCT of day D, in case an mFRR Balancing Capacity was awarded by ELIA to the BSP, the latter is required to submit at least the concerned awarded volume in the form of mFRR Energy Bids. ELIA monitors the compliance of the BSP with this mFRR Obligation via the “mFRR Energy Bid submission control” (i.e., the control of the “MW Made Available”) explained in section 11.1.1.

#### 3.2.1.2. Obligation coming from the Code of Conduct

Regardless of the mFRR (or aFRR) Obligation and in accordance with the article 242 of the Code of Conduct, a BSP must put at the disposal of ELIA the **(upward or downward) active power** that remains available on its Technical Facilities that are either:

- PGM (i.e., Power Generating Modules) with maximum power greater than or equal to 25 MW; or
- **energy storage units of type C or D**, in accordance with the maximum power thresholds defined in the Federal Grid Code.

This implies that:

- upward active power on those Technical Facilities that is not committed as balancing capacity or as a result of a trade on the wholesale energy market, must be offered in upward mFRR (or aFRR) Energy Bid(s) to ELIA;
- active power on those Technical Facilities that is traded on the wholesale energy market, must be offered in downward mFRR (or aFRR) Energy Bid(s) to ELIA.

BSPs currently have a choice to offer the concerned energy for either mFRR or aFRR.

Note that for the Technical Facilities subject to article 242 of the Code of Conduct, the obligation is only relevant for the mFRR Service in case the active power can be delivered in compliance with the mFRR requirements as described in the T&C BSP mFRR. The availability of the mFRR energy on these Technical Facilities depends on the energy direction, on the Operating Mode and on the ramping rate.

### 3.2.2. Voluntary provision of mFRR Energy Bids

A BSP can offer **on a voluntary basis** upward or downward mFRR Energy Bids that are not subject to the above-mentioned obligations, to ELIA in the form of balancing Energy Bids.

## 3.3. Delivery Points and mFRR Providing Groups

Attention point in comparison to current design

In the current design only one Delivery Point of the type DP<sub>SU</sub> can be listed in an mFRR Energy Bid.

SOGI definitions – Article 3

(10) **‘reserve providing unit’** means a single or an aggregation of power generating modules and/or demand units connected to a common connection point fulfilling the requirements to provide FCR, FRR or RR;

(11) **'reserve Providing Group'** means an aggregation of power generating modules, demand units and/or reserve providing units connected to more than one connection point fulfilling the requirements to provide FCR, FRR or RR;

BSPs provide mFRR energy on Delivery Points. Delivery Points are always located behind one connection point to the ELIA grid and therefore represent “reserve providing units” (as defined in SOGL article 3). With the introduction of explicit bidding for all types of mFRR Energy Bids, the rules for aggregating Delivery Points in mFRR Energy Bids will change and will be as follows:

- **An mFRR Providing Group of DP<sub>SU</sub>:**

A Delivery Point DP<sub>SU</sub> (or 'single-unit' Delivery Point) corresponds to one Technical Unit (possibly the same as the Technical Facility) in the ELIA LFC Block for which ELIA receives Daily Schedules<sup>17</sup>. An mFRR Energy Bid may be offered on an aggregation of Delivery Points of the type DP<sub>SU</sub> as long as all the DP<sub>SU</sub> belong to the same Technical Facility. For example: the mFRR energy available on a CCGT (a Technical Facility) may, depending on the Operating Mode, be offered on the whole of the plant rather than separately on the Technical Units (2 gas turbines and 1 steam turbine).

- **An mFRR Providing Group of DP<sub>PG</sub>:**

A BSP may offer an mFRR Energy Bid on any group of DP<sub>PG</sub> (i.e., Technical Units located within the ELIA LFC Block for which ELIA does not receive a Daily Schedule). BSPs typically group DP<sub>PG</sub> to benefit from a portfolio effect. Concrete rules on the aggregation of Delivery Points in mFRR Energy Bids are explained in section 7.1.2.1.

### 3.4. Combinability rules

A Delivery Point part of an BSP Contract mFRR can be included in a BSP Contract FCR, a BSP Contract aFRR and/or an FSP Contract DA/ID with ToE at the condition that the BSP is the same party. The combination of Balancing Services on other Delivery Points upstream or downstream of a Delivery Point supplying the mFRR Service is, however, not possible (apart from specific situations tolerated by ELIA as explained below in this section).

As explained in the previous chapter, available active power on DP<sub>SU</sub> must be offered for Balancing Services. The BSP has the choice to offer the volume as contracted FCR, aFRR or mFRR, or as non-contracted aFRR or mFRR. For a specific quarter-hour, the BSP can offer the volume fully for one of these services or the BSP can split up the volume across several Balancing Services.

A Delivery Point DP<sub>PG</sub> included in an mFRR Energy Bid cannot be included in an aFRR Energy Bid for the same quarter-hour and/or participate in an activation in the context of a FSP Contract DA/ID with ToE.

Any other Delivery Point, upstream or downstream of the Delivery Point supplying mFRR Service, cannot be part of any other Balancing Service, including mFRR Service itself, independently from the fact that the BSP is the same party. In other words – as per Figure 6 – there cannot be a cascade between two Delivery Points in order to avoid any influence from one on the other. Each Delivery Point must be independent of each other.

---

<sup>17</sup> This is typically due to scheduling obligations. Information on scheduling design can be consulted in iCAROS design notes: <https://www.ELIA.be/en/electricity-market-and-system/system-services/alleviating-congestion-risk>

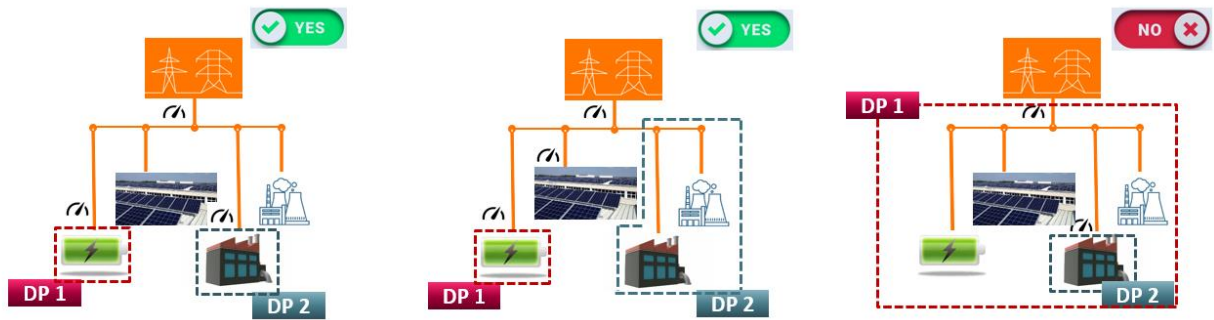

Figure 6. Current possibilities for multiple DPs behind the same Access Point

However, if the BSP of both Delivery Points is the same party, ELIA will tolerate the situation, only for the FCR, at the condition that the BSP renounces to invoke any influence of the Balancing Service supplied downstream on the Balancing Service supplied upstream.

## 4. Balancing Service Provider (BSP)

<b>EBGL definitions – Article 2</b>
(6) ‘ <b>balancing service provider</b> ’ means a market participant with reserve-providing units or reserve-Providing Groups able to provide Balancing Services to TSOs;
<b>Federal Grid Code</b>
<b>Article 225.</b> De aanbieder van balanceringsdiensten stelt aan de transmissienetbeheerder aanbiedingen van balanceringsenergie ter beschikking overeenkomstig aan de modaliteiten en voorwaarden van toepassing op de aanbieders van balanceringsdiensten. [...] / Le fournisseur de services d’équilibrage soumet au gestionnaire de réseau de transport des offres d’énergie d’équilibrage conformément aux modalités et conditions applicables aux fournisseurs de services d’équilibrage. [...]
<b>Article 226 § 3.</b> De aanbieder van balanceringsdiensten is aangeduid door een betrokken netgebruiker volgens de bepalingen voorzien in de modaliteiten en voorwaarden van toepassing op de aanbieders van balanceringsdiensten. Wanneer er geen enkele aanbieder voor balanceringsdiensten is aangeduid voor de installaties bedoeld in paragraaf 1, dan wordt de betrokken netgebruiker automatisch aanbieder van balanceringsdiensten en krijgt hij de verplichting toegewezen om het beschikbare vermogen ter beschikking te stellen van de transmissienetbeheerder zoals bepaald in paragraaf 1. / Le fournisseur de services d’équilibrage est désigné par un utilisateur de réseau concerné selon des dispositions prévues dans les modalités et conditions applicables aux fournisseurs de services d’équilibrage. Lorsqu’aucun fournisseur de services d’équilibrages n’est désigné pour les installations visées au paragraphe 1er l’utilisateur de réseau concerné devient par défaut fournisseur de services d’équilibrage et se voit attribuer l’obligation de mise à disposition de puissance disponible au gestionnaire de réseau de transport tel que visé au paragraphe 1er.

In accordance with the EBGL, the Code of Conduct and the Federal Grid Code, the **BSP** is the market party that provides Balancing Services to ELIA and therefore concludes the BSP Contract mFRR<sup>18</sup> with ELIA. The BSP is either a Grid User or a third party appointed by the Grid User. The “third party BSP” has an agreement (i.e., the Grid User Declaration) with the Grid User of the Technical Facility that will be used by the BSP to offer Balancing Services.

### 4.1. Qualification as BSP for mFRR

A market party can become a BSP by going through an application procedure<sup>19</sup>. The procedure includes the completion of an application form, sworn statements and a financial screening. Following approval of the application, the BSP Contract mFRR must be signed in order to be allowed to participate in the mFRR Service.

### 4.2. Interdependencies with other parties

<b>EBGL definitions – Article 2</b>
(7) ‘ <b>balance responsible party</b> ’ means a market participant or its chosen representative responsible for its imbalances;
<b>SOGL definitions – Article 3</b>

<sup>18</sup> The same applies for aFRR and FCR services.

<sup>19</sup> Available online: <https://www.ELIA.be/en/electricity-market-and-system/system-services/becoming-a-balancing-service-provider>

(90) ‘**scheduling agent**’ means the entity or entities with the task of providing schedules from market participants to TSOs, or where applicable third parties;

**Federal Grid Code**

**Article 200. § 3.** De transmissienetbeheerder communiceert aan de evenwichtsverantwoordelijke alle relevante informatie, in geval van activatie van energie die leidt tot een wijziging van de injecties en/of afnames van actief vermogen die aan deze evenwichtsverantwoordelijke zijn toegewezen overeenkomstig de bepalingen beschreven in de modaliteiten en voorwaarden van toepassing op de evenwichtsverantwoordelijken. / Le gestionnaire de réseau de transport communique au responsable d’équilibre de l’information pertinente, en cas d’activation d’énergie menant à une modification des injections et/ou prélèvements de puissance active qui sont attribués à ce responsable d’équilibre selon des modalités décrites dans les modalités et conditions applicables aux responsables d’équilibre.

**Article 247.** Wanneer een installatie ook deelneemt aan één of meerdere balanceringsdiensten met een aanbieder van balanceringsdiensten, overeenkomstig boek 6 van deel 5, kan de programma-agent van de installatie enkel de betrokken netgebruiker of de betrokken aanbieder van balanceringsdiensten zijn. / Lorsqu’une installation participe également à un ou des services d’équilibrage avec un fournisseur de services d’équilibrages, conformément au livre 6 de la partie 5, le responsable de la programmation de l’installation ne peut être que l’utilisateur de réseau concerné ou le fournisseur de services d’équilibrages concerné.

The most relevant interactions with other responsibilities related to Balancing Services in specific or Ancillary Services in general concern the **interdependencies of the BSP with:**

- the **Balance Responsible Party** (BRP), as per section 4.2.1; and
- the **Scheduling Agent**, as per section 4.2.2.

#### 4.2.1. Impact of mFRR on the BRP

The BSP must designate a BRP (i.e., the “BRP<sub>BSP</sub>”) who will take **responsibility for imbalances that may result from incorrect activations of mFRR Energy Bids**. In addition, all Delivery Points used by a BSP for the provision of Balancing Services must be related to an Access Point that is included in the perimeter of a BRP (“BRP<sub>source</sub>”). In accordance with article 200 of the Federal Grid Code, ELIA informs the BRP<sub>BSP</sub> and the BRP<sub>source</sub> of the potential impact of the activation of mFRR Energy Bid(s) on the BRP perimeter. In case of an activation of mFRR Energy Bid(s), the perimeters of the BRP<sub>source</sub> and the BRP<sub>BSP</sub> are corrected in accordance with the BRP Contract and, if applicable, the ToE Rules.

In case of activation of an mFRR Energy Bid of the quarter-hour QH<sub>0</sub>, ELIA will correct the BRP perimeter for the quarter-hour QH<sub>0</sub> with the **mFRR energy requested** (also referred to as the “block approach”):

$$\text{energy appointed to balancing perimeter} = \text{mFRR energy requested}$$

The determination of the mFRR energy requested is defined in section 10.2.2.

Based on an analysis recently realized by ELIA<sup>20</sup>, it has been decided to maintain de **the current approach for the perimeter adjustments** because:

<sup>20</sup> A public consultation has been launched on that topic. All the documents are available here: [Public consultation of the study on the BRP perimeter adjustments applied in case of the activation of mFRR or redispatch energy bids \(elia.be\)](#).

- Perimeter adjustments based on the requested volume have fundamental benefits compared to perimeter adjustments with the delivered volume (cf. the conclusions of sections 3 and 5 in the “study on the BRP perimeter adjustments applied in case of the activation of mFRR or redispatch energy bids”<sup>20</sup>)
- From the different variants of the perimeter adjustments based on the requested volume, Elia is convinced that the current approach for the perimeter adjustments provides the right incentives for delivering the requested service, enables a split of roles and forms the most pragmatic option.

**Examples:**

- **Case 1: Scheduled Activation**

The activation request is sent 7.5 minutes before the start of the quarter-hour for which the concerned mFRR Energy Bid was submitted.

Quarter-hour	mFRR Requested [MW]	mFRR energy requested [MWh]	mFRR Energy in BRP <sub>BSP</sub> perimeter [MWh]
08:00 – 08:15	0	0	0
08:15 – 08:30	100	$100 \times \frac{1}{4} = 25$	25
08:30 – 08:45	0	0	0

Table 2: Example of balancing perimeter correction for a SA of an mFRR Energy Bid

- **Case 2: Direct Activation**

The activation request is sent 3 minutes after the Point of Scheduled Activation for which the concerned mFRR Energy Bid was submitted.

In such a case,  $\Delta t$ , being the duration in minutes between the Direct Activation request and the Point of Scheduled Activation for the concerned quarter-hour, is equal to 3 minutes.

Quarter-hour	mFRR Requested [MW]	mFRR Energy Requested [MWh]	mFRR Energy in BRP <sub>BSP</sub> perimeter [MWh]
08:00 – 08:15	0	0	0
08:15 – 08:30	100	$100 \times \frac{15-3}{15} \times \frac{1}{4} = 20$	20
08:30 – 08:45	100	$100 \times \frac{1}{4} = 25$	25
08:45 - 09:00	0	0	0

Table 3: Example of balancing perimeter correction for a DA of an mFRR Energy Bid

Non-contracted energy can also be deployed by the BRP (i.e., to do (self-balancing, reactive balancing or an intraday trade), even if included in a non-contracted mFRR Energy Bid).<sup>21</sup> If the volume of an mFRR Energy Bid is used by the BRP to do an intraday trade or self-/reactive balancing before the BE GCT, then the BSP must update the mFRR Energy Bid. If such a thing happens after the BE GCT, ELIA foresees to allow the BSP to request a reduction of the bid(s) volume until 5 minutes after the start of the concerned quarter-hour, for limited reasons and with justification as, contrarily to the current contract, the BSP will no longer be able to reject an mFRR activation. The possibility to reduce bid volumes is described in section 7.4. Note that other bid characteristics can no longer be changed after BE GCT.

<sup>21</sup> If the BRP needs to use energy offered in a contracted mFRR Energy Bid, then in accordance with the BSP Contract mFRR, the party taking on the roles of both BSP and BRP<sub>source</sub> must first ask the explicit approval of ELIA to deviate from the standard rules (this is called the “activation at own expense” in the BSP Contract mFRR).



## 4.2.2. Impact of mFRR on the Scheduling Agent

As described in section 3.3, ELIA receives Daily Schedules (in MW) for Delivery Points DP<sub>SU</sub>. The schedules are delivered to ELIA by the Scheduling Agent. In accordance with article 247 of the Federal Grid Code, in case a facility, participating to the mFRR Balancing Service, is also subject to scheduling obligations, the Scheduling Agent must be the BSP or the Grid User.

Active power offered by the BSP to ELIA in (a) **contracted** mFRR Energy Bid(s), **cannot also be offered** by the Scheduling Agent in (a) **Redispatching Energy Bid(s)** for the same quarter-hour.

However, according to the article 248 of the Federal Grid Code, active power coming from a DP<sub>SU</sub> offered in (a) **non-contracted** mFRR Energy Bid(s)<sup>22</sup> submitted as required by the obligations set for in section 3.2.1.2, must also be offered to ELIA in (a) Redispatching Energy Bid(s). Therefore, this **energy must be included in (a) Balancing (mFRR or aFRR) Energy Bid(s) of the BSP as well as in (a) Redispatching Energy Bid(s) of the Scheduling Agent.**

The activation of a Redispatching Energy Bid is usually requested ahead of the BE GCT (RT-25') and thereby the BSP can still update its mFRR Energy Bids, reducing the volume with the amount that would already be used for redispatching.

The activation of a non-contracted mFRR Energy Bid does not impose a problem for the Scheduling Agent. The Scheduling Agent can of course not take any actions that counter the mFRR activation. An activation for redispatching after the timing of mFRR activation is rare because remedial actions in the framework of congestion management are mostly requested ahead of the balancing timeframe and not in (near) real-time.

---

<sup>22</sup> This also applies for aFRR.

## 5. Tests prior to participation to the mFRR Service

Attention point in comparison to current design

The future design requires an update of the prequalification test due to the change in activation types and profiles.

SOGL – Article 159 on FRR prequalification process

1. By 12 months after entry into force of this Regulation each TSO shall develop a FRR prequalification process and shall clarify and make publicly available its details.
2. A potential FRR provider shall demonstrate to the reserve connecting TSO or the TSO designated by the reserve connecting TSO in the FRR exchange agreement that it complies with the FRR minimum technical requirements in Article 158(1), the FRR availability requirements in Article 158(2), the ramping rate requirements in Article 158(1) and the connection requirements in Article 158(3) by completing successfully the prequalification process of potential FRR providing units or FRR Providing Groups, described in paragraphs 3 to 6 of this Article. [...]

In accordance with article 159(2) of the SOGL, a BSP offering the mFRR Service must complete a prequalification process to – among other things – demonstrate the compliance of its portfolio with the requirements of the mFRR Service.

In the context of this prequalification process, after the signature of the BSP Contract mFRR, the BSP must successfully complete:

- the communication test, as described in section 5.1; and
- a prequalification test, as described in section 5.2.

### 5.1. Communication test

After signature of the BSP Contract mFRR and before submission of any mFRR Capacity Bid or mFRR Energy Bid, the BSP must successfully complete the communication test. The BSP must always respect the requirements of the communication test during the validity of the BSP Contract mFRR.

During the communication test ELIA will check that the BSP is operationally able to receive, interpret and send the signals:

- of an activation of the mFRR Service in case the BSP wants to be allowed to submit mFRR Energy Bids; and
- of a prequalification test, an activation of an mFRR Energy Bid for redispatching and an availability test in case the BSP wants to be allowed to submit mFRR Capacity Bids.

### 5.2. Prequalification test

The BSP must perform a prequalification test prior to first participation in capacity auctions or if it wishes to increase its mFRR<sub>max</sub>. Signature of the BSP Contract mFRR and achievement of the communication test, are required before performance of a prequalification test.

The outcome of the prequalification test(s) determines the maximal mFRR Power (mFRR<sub>max</sub>) that can be offered to ELIA by the BSP in mFRR capacity auctions.

### 5.2.1. Organization of a prequalification test

To organize a prequalification test, the BSP and ELIA agree on a time window of 24 hours. For this time window of 24 hours the BSP should submit mFRR prequalification bids<sup>23</sup> that ELIA can activate by surprise.

Transfer of Energy is applicable in case of activation for a prequalification test (if the DP is subject to ToE).

The prequalification test is not remunerated by ELIA.

### 5.2.2. Specifications of a prequalification test

During a prequalification test, the following rules have to be respected:

- For a Delivery Point DP<sub>SU</sub>, a prequalification test is performed for at least one of the possible Operating Modes of the Technical Facility it is a part of<sup>24</sup>;
- Delivery Points DP<sub>PG</sub> can be tested individually or as part of a Providing Group;
- A Delivery Point submitted in an mFRR Energy Bid in the framework of a prequalification test cannot also be included in an aFRR Energy Bid, an mFRR Energy Bid, a Supporting aFRR Providing Group, a Supporting mFRR Providing Group or another prequalification test for the same quarter-hour.

As in the current design for mFRR Standard, the prequalification test lasts in total 10 quarter-hours and consists of two activation blocks with a “non-activation pause” in between. The purpose of the “non-activation pause” is to verify that the unit(s) concerned by the prequalification test is able to start again after a short “activation stop”.

The prequalification test profile has been updated to take into account the new activation types and profiles:

- **First activation** requested by ELIA (as if ELIA was requesting a Scheduled Activation):
  - An activation is requested 7.5 minutes before the start of the quarter-hour QH2;
  - From this request, the BSP disposes of 12.5 minutes (Full Activation Time) to reach the mFRR Power that it intends to prequalify;
  - After the Full Activation Time, the BSP delivers the mFRR Power that it intends to prequalify, for 5 minutes in the quarter-hour QH2;
  - The downward ramping to the Baseline starts 5 minutes before the end of the quarter-hour for which the activation was requested (i.e. QH2).
- **No activation** requested by ELIA for 4 quarter-hours (i.e. for QH3, QH4, QH5 & QH6).
- **Second activation** requested by ELIA (as if ELIA was requesting a Scheduled Activation for 4 consecutive quarter-hours):
  - An activation is requested 7.5 minutes before the start of the quarter-hour QH7;
  - From this request, the BSP disposes of 12.5 minutes (Full Activation Time) to reach the mFRR Power that it intends to prequalify;
  - After the Full Activation Time, the BSP delivers the mFRR Power that it intends to prequalify, for 50 minutes in the quarter-hours QH7, QH8, QH9 and QH10;
  - The downward ramping to the Baseline starts 5 minutes before the end of the last quarter-hour for which the activation was requested (i.e. QH10).

---

<sup>23</sup> So the BSP will have to submit 96 prequalification bids to cover the time window of 24 hours.

<sup>24</sup> For instance, in case a CCGT may participate as a CCGT or as an OCGT, two prequalification tests may be foreseen for the Delivery Point DP<sub>SU</sub> “GT”: one for the OCGT Operating Mode and one for the CCGT Operating Mode.

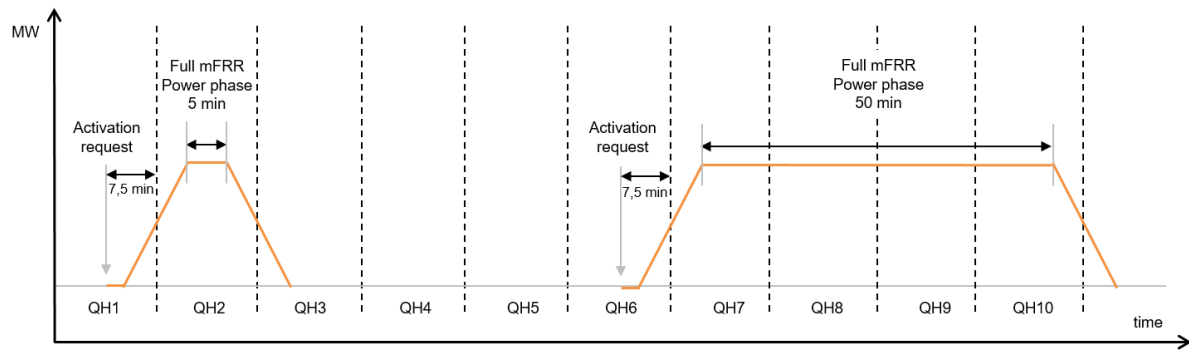

Figure 7. Prequalification test profiles

### 5.2.3. Outcomes of a prequalification test

For the quarter-hours QH2, QH7, QH8, QH9 and QH10, ELIA determines the mFRR Power that is supplied. The lowest mFRR Power supplied amongst the 5 concerned quarter-hour determines the result of the test.

From the moment ELIA provides the result of the prequalification test to the BSP, the BSP communicates to ELIA the contribution of each Delivery Point included in the test (i.e.  $DP_{mFRR,cb,up}$ ), to this result; provided that:

- The sum of the  $DP_{mFRR,cb,up}$  of each DP included in the prequalification test is exactly equal to the prequalification test result; and
- The  $DP_{mFRR,cb,up}$  of a DP included in the prequalification test can never be higher than its  $DP_{mFRR,max,up}$ .

The  $mFRR_{max}$  is determined at the level of the BSP by summing the  $DP_{mFRR,cb,up}$  of each Delivery Point included in the BSP's portfolio, while respecting the following conditions:

- If a new prequalification test is organized for one (or more) Delivery Point(s) already included in the BSP's Pool, only the last updated  $DP_{mFRR,cb,up}$  will be taken into account in the  $mFRR_{max}$  determination.
- If for a  $DP_{SU}$ , a BSP has performed multiple prequalification tests for different Operating Modes, then only the maximum  $DP_{mFRR,cb,up}$  of the different tests, will be taken into account in the  $mFRR_{max}$  determination.

### 5.2.4. Possible modifications of the $mFRR_{max}$

A BSP may also use a prequalification test to increase its total prequalified volume:

- The BSP either includes the entire Pool in the test and thereby the test sets the new prequalified volume; or
- The BSP prequalifies (a) new Delivery Point(s) and the BSP's prequalified volume is increased with the volume prequalified based on the test.

No test is required if a Delivery Point is added without impact on  $mFRR_{max}$  (i.e.  $DP_{mFRR,cb,up}$  is declared by the BSP as equal to 0 MW). A test is not mandatory if the BSP removes a Delivery Point from its pool. In this situation, the concerned  $DP_{mFRR,cb,up}$  will be subtracted from  $mFRR_{max}$ .

### 5.2.5. Modalities to modify the Baseline of a $DP_{PG}$

In case the BSP wishes to modify the baselining method of a Delivery Point  $DP_{PG}$  that has a  $DP_{mFRR,cb,up}$  higher than 0 (zero) MW, a new prequalification test, must be performed at least for the concerned Delivery Point  $DP_{PG}$ .

## 6. Capacity procurement

### 6.1. Procurement of mFRR capacity

As mentioned in section 2, by the entry into force of the new mFRR design described in this design note, the mFRR Flex product will be phased out completely.

Since February 2020, ELIA procures all mFRR Balancing Capacities for Day D by running one capacity auction for each CCTU (i.e. block of 4 hours<sup>25</sup>) of Day D, i.e. in total 6 capacity auctions for Day D. The 6 capacity auctions are performed at the same time in Day D-1 for delivery on Day D, taking into account the following timeline:

- mFRR Capacity GOT for the 6 capacity auctions of Day D-1 is scheduled on Day D-14 at 00:00 CET;
- Publication of the required volume of mFRR Balancing Capacity for each CCTU, is performed by ELIA in accordance with article 6(5) of the LFC Means;
- mFRR Capacity GCT for the 6 capacity auctions of Day D-1 is scheduled on Day D-1 at 10:00 CET;
- Publication of the results for the 6 auctions of Day D-1 is performed at the latest Day D-1 at 10:30 CET.

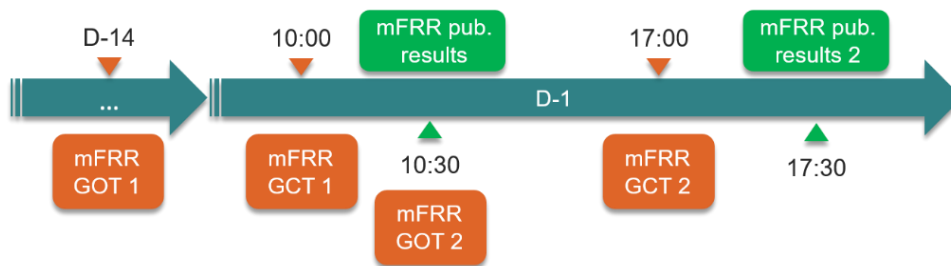

Figure 8. Capacity auction process

For each mFRR Capacity Bid, the BSP defines the following specifications:

- The CCTU;
- An upward divisible volume (in MW), taking into account the following specifications:
  - The minimum size of an mFRR Balancing Capacity Bid is 1MW;
  - The volume granularity of an mFRR Balancing Capacity Bid is 1MW;
  - Per CCTU, the total offered volume of mFRR Balancing Capacity must be less than or equal to the  $mFRR_{max}$  (see section 5.2) of the concerned BSP.
- The price applicable (in €/MW/h), defined with maximum 2 decimals.

ELIA selects the capacity bids for each CCTU based on the “merit order” principle. The bids are ranked from lowest to highest price and ELIA selects bids until the dimensioned demand for mFRR Balancing Capacity is covered. The results of the mFRR Capacity auctions are known by 10:30 at the latest and published immediately on the ELIA web site<sup>26</sup>.

In case of a lack of liquidity or IT problems, it is possible that not all mFRR Balancing Capacity is procured in the first auctions at 10:00. In such a case, ELIA opens a second capacity auction for the concerned CCTU, with the following characteristics:

- mFRR Capacity GOT is opened on Day D-1, no later than 30 minutes after publication of the result of the first capacity auction;

<sup>25</sup> The CCTU or “Capacity Contracting Time Unit” defined in the T&C BSP mFRR corresponds to the “validity period” of the SPBC.

<sup>26</sup> Available via <https://www.ELIA.be/en/grid-data/balancing/capacity-auction-results>

- Publication of the required volume of mFRR Balancing Capacity is performed by ELIA on Day D-1, no later than 30 minutes after publication of the result of the first capacity auction;
- mFRR Capacity GCT is scheduled on Day D-1 at 17:00 CET;
- Publication of the result is performed at the latest Day D-1 at 17:30 CET.

## 6.2. Transfers of mFRR capacity

The only change foreseen in the future design regarding the Transfer of Obligation is the creation a “conditional Transfer of Obligation” in the framework the enabling of a Neutralization Time.

The mFRR capacity auctions result in mFRR Obligations for the concerned BSPs: the BSP must submit mFRR Energy Bids with an offered volume of at least the awarded capacity.

However, it is possible that after the mFRR capacity auction, a BSP is confronted with issues which no longer allows it to meet its mFRR Obligation. In this case ELIA allows the BSP to transfer a part or all of the mFRR Obligation to one or more other BSP(s) (i.e. the Counterpart BSP) for one or more quarter-hours.

The transfer must be communicated to ELIA and accepted by one hour prior to the start of the first quarter-hour for which a transfer would take place.

When a Transfer of Obligation is accepted, ELIA adapts the mFRR Obligation of the BSP and the Counterpart BSP for the applicable quarter-hour(s) by:

- adding the volume transferred to the mFRR Obligation of the party taking over the mFRR Obligation; and
- reducing by the volume transferred the mFRR Obligation of the party ceding the mFRR Obligation.

The BSP and the Counterpart BSP undertake the necessary actions to provide the mFRR Service for the applicable quarter-hour(s) (without any action by ELIA). Consequently, the availability control and the activation control as well as the resulting penalties for non-compliance, among other provisions, will be based on the amended mFRR Obligation of the BSP and the Counterpart BSP, resulting from the Transfer of Obligation.

In order to reflect the agreed Transfer of Obligation, the Counterpart BSP and the BSP should update their concerned mFRR Energy Bids at the latest at the mFRR Balancing GCT of the first quarter-hour for which the Transfer of Obligation applies.

Note that a transfer of mFRR Capacity Obligation does not affect the remuneration of mFRR Capacity as this only takes into account the awards during the auction and not the transfers afterwards. BSPs involved in a transfer of mFRR Capacity obligation must discuss the terms of the trade among them.

### Conditional Transfer of obligation

In the framework of the BSP Facilitation discussions <sup>27</sup>, ELIA suggested to allow the BSP to use a Neutralization Time (i.e. The time after the activation of an mFRR Energy Bid, part of a bid group, during which subsequent mFRR Energy Bids, part of the same bid group, cannot be activated) when submitting their mFRR Energy Bids.

In this context, the BSP (or the Counterpart BSP) has the possibility to submit a conditional Transfer of Obligation so that the Transfer of Obligation only applies in case the Neutralization Time, submitted by the BSP (or the Counterpart BSP, if applicable) for the quarter-hour(s) concerned by this Transfer of Obligation, has been enabled.

---

<sup>27</sup> Cf. the workshop organized with the market parties on July 7, 2023.

## 7. Submission of mFRR Energy Bids

### 7.1. Submission of mFRR Energy Bids to ELIA

In the current design, a non-contracted mFRR Energy including DP<sub>SU</sub> is offered implicitly. This has changed to explicit bidding in the new design. mFRR Energy including DP<sub>PG</sub> and contracted mFRR Energy including DP<sub>SU</sub> are already explicit bids in the current design.

BSPs submit mFRR Energy Bids to ELIA as explicit bids and ELIA will transmit them to the mFRR-Platform.

The timeline for bid submission and the bid characteristics have been determined at the European level. European regulation still allows some details to be determined at a national level. ELIA therefore added some local bid characteristics for purpose of monitoring, controlling, preprocessing & BSP facilitating (e.g., the contracted or non-contracted status and the Neutralization time).

#### 7.1.1. Timeline for energy bid submission

Important information no longer valid in the next design:

- The mFRR Balancing GCT is 45' before the start of the quarter-hour.
- Bidding, selection and activation of mFRR Energy Bids are organized locally (with the exception of the Reserve Sharing Agreements).

**mFRR IF**

Article 2 – Definitions

(s) ‘**mFRR market time unit**’ (hereafter “**mFRR MTU**”) means a period of 15 minutes length. The first mFRR MTU starts at 00:00 market time. The mFRR MTUs shall be consecutive and not overlapping;

Article 8 – Balancing energy gate opening and gate closure times for the standard mFRR balancing energy product bids

1. The **balancing energy gate opening time** for the submission of a standard mFRR balancing energy product bid by BSPs to the Participating TSO shall be no later than 12:00 market time for all mFRR MTUs of the next day.
2. The **balancing energy gate closure time** for the submission of a standard mFRR balancing energy product bid by BSPs to the Participating TSO shall be **25 minutes** before the beginning of the mFRR MTU of the respective standard mFRR balancing energy product bid. The same balancing energy gate closure time applies for specific product bids converted into standard mFRR balancing energy product bids.

**EBGL**

Article 2 – Definitions

(27) ‘**balancing energy gate closure time**’ means the point in time when submission or update of a balancing energy bid for a standard product on a common merit order list is no longer permitted;

(38) ‘**TSO energy bid submission gate closure time**’ means the latest point in time when a connecting TSO can forward the balancing energy bids received from a BSP to the activation optimisation function;

**Article 20.6** – [...] all TSOs shall implement and make operational the European platform for the exchange of balancing energy from frequency restoration reserves with manual activation and they shall use the European platform to:

(a) submit all balancing energy bids from all standard products for frequency restoration reserves with manual activation;

(b) exchange all balancing energy bids from all standard products for frequency restoration reserves with manual activation, except for unavailable bids pursuant to Article 29(14);

(c) strive to fulfil all their needs for balancing energy from the frequency restoration reserves with manual activation.

Article 24 – Balancing energy gate closure time

3. After the balancing energy gate closure time, the BSPs shall no longer be permitted to submit or update their balancing energy bids.

4. After the balancing energy gate closure time, BSPs shall report to the connecting TSO any unavailable volumes of balancing energy bids without undue delay in accordance to 158(4)(b) and 161(4)(b) of Regulation (EU) 2017/1485. If the BSP has a connection point to a DSO, and if required by the DSO, the BSP shall also report any unavailable volumes of balancing energy bids to the DSO without undue delay.

Article 29 – Activation of balancing energy bids from common merit order list

9. Each connecting TSO shall submit, prior to the TSO energy bid submission gate closure time, all balancing energy bids received from BSPs to the activation optimisation function, taking into account the requirements in Articles 26 and 27. The connecting TSOs shall not modify or withhold balancing energy bids, except for:

(a) balancing energy bids related to Articles 26 and 27;

(b) balancing energy bids that are manifestly erroneous and include an unfeasible delivery volume;

(c) balancing energy bids that are not forwarded to the European platforms in accordance with paragraph 10.

14. Each TSO may declare the balancing energy bids submitted to the activation optimisation function unavailable for the activation by other TSOs because they are restricted due to internal congestion or due to operational security constraints within the connecting TSO scheduling area.

BSPs can submit mFRR Energy Bids for each quarter-hour of a day D. A quarter-hour corresponds to one “mFRR Market Time Unit” (or “mFRR MTU”).

As defined in the mFRR IF, the Balancing Energy Gate Closure Time (BE GCT or mFRR Balancing GCT) is 25 minutes before the start of the concerned quarter-hour (QH). mFRR Energy Bids can be submitted and updated until BE GCT. At BE GCT, the submitted bids are firm and can no longer be modified by the BSP. The specific circumstances in which a modification by the BSP after BE GCT is allowed and the applicable rules are explained in the section 7.1.2.4.

Contracted mFRR Energy Bids for possible activation on Day D, have to be submitted by the BSP to ELIA at the latest in day-ahead (Day D-1) at 15:00 CET.

### 7.1.2. Characteristics of mFRR Energy Bids set by the BSP

Attention point in comparison to current design:

- The current list of bid characteristics for explicit bidding is more limited and there are different rules than those given by the European mFRR-Platform.
- Fully new bid characteristics are: activation type (currently not a bid characteristic), exclusive groups, and conditional linking.
- The bid characteristic on the parent-child group is modelled differently.

Explicit bidding of mFRR Energy Bids entails the submission by the BSP of mFRR Energy using characteristics to reflect the conditions under which the energy can be activated. Article 25 of the EBGL and in more detail article 7 of the mFRR IF give a list of bid characteristics, focusing on the characteristics for submission to the mFRR-Platform. mFRR Energy Bids submitted to ELIA have some additional bid characteristics for local use (contractual interactions



with other design aspect or links with national system operations). ELIA (as each TSO) also sets some bid characteristics in the preprocessing before transmitting the bids to the mFRR-Platform. Table 4 and Table 5 give the lists of the bid characteristics, which are discussed in more detail in the next subsections.

mFRR-Platform bid characteristics	Added ELIA bid characteristics
Concerned quarter-hour	BSP Facilitation (optional)
Direction (up or down)	List of Delivery Points
Activation type	Link with mFRR Obligation
(Maximum) Bid volume	
Minimum bid volume (indicating bid divisibility)	
Bid price	
Bid linking	

Table 4 List of characteristics of mFRR Energy Bids declared by the BSP

mFRR-Platform bid characteristics
Availability status for mFRR-Platform

Table 5 List of characteristics of mFRR Energy Bids declared by ELIA

ELIA has collected examples of energy bidding in a manual<sup>28</sup>. This manual shows the eagerly awaited cases of bidding.

### 7.1.2.1. Concerned quarter-hour

An mFRR Energy Bid is related to only one Market Time Unit. For the submission of an mFRR Energy Bid, the BSP has therefore to indicate to which quarter-hour it is related.

### 7.1.2.2. Direction

mFRR IF – Article 7
3(c) the <b>direction</b> of the bid: positive or negative balancing energy;

An mFRR Energy Bids offers either positive or negative energy volume:

- **Positive energy** indicates an increase in net injection or a decrease in net offtake, following the increase of electricity production or the decrease of electricity consumption. Bids offering positive energy are also referred to as “**incremental bids**” (or “upward bid”) and are used for **upward activation**.
- **Negative energy** indicates a decrease in net injection or an increase in net offtake, following the decrease of electricity production or the increase of electricity consumption. Bids offering negative energy are also referred to as “**decremental bids**” (or “downward bid”) and are used for **downward activation**.

The mFRR-Platform does not know which Delivery Points are included in the bid. Due to the optimization principles of the mFRR-Platform or subsequent demands for Scheduled Activation or Direct Activations, both positive and negative energy bids can be selected for activation in the concerned or consecutive quarter-hour (see section 9.4). Therefore, it is possible that a Delivery Point is included in bids selected for activation in both directions. If needed, a BSP can avoid this by using other bid characteristics, such as exclusive groups (see section 7.1.2.7.2) and conditional linking (see section 7.1.2.7.3).

<sup>28</sup> The Manual on Energy Bidding is available online via <https://www.elia.be/fr/marche-de-electricite-et-reseau/services-auxiliaires/maintenir-equilibre/mfr>.

### 7.1.2.3. Activation type

Important information no longer valid in the next design: All mFRR Energy Bids must be available for Scheduled Activation and Direct Activation.

**mFRR IF definitions – Article 2**

(d) **‘direct activatable bid’** means a standard mFRR balancing energy product bid that can be activated at any point of time following the point of Scheduled Activation of the quarter-hour for which the bid is submitted and until the point of Scheduled Activation of the subsequent quarter-hour. Every direct activatable bid is scheduled activatable bid as well;

(w) **‘scheduled activatable bid’** means a standard mFRR balancing energy product bid that can only be activated at one specific point in time, i.e. the point of Scheduled Activation, with respect to the period of time for which the balancing energy bid is submitted;

**mFRR IF – Article 7**

2. The delivery of a direct activatable bid shall include the mFRR MTU following the one the bid refers to.

Methodology on standard products for balancing capacity

**Whereas 9.** For the specific case of mFRR which has two activation types (Scheduled Activation and Direct Activation), the procured standard product for balancing capacity must be able to deliver a mFRR standard product for balancing energy with Direct Activation for the purpose of restoring frequency within the Time to Restore Frequency (TTRF).

**Article 2 Definitions and interpretation - 1.** For the purposes of the SPBC methodology, the terms used shall have the meaning given to them in Article 2 of the Electricity Regulation, Article 3 of the SO Regulation and Article 2 of the EB Regulation. In addition, in this SPBC methodology the following terms shall apply:

[...] (b) **‘standard mFRR balancing capacity product’** means the standard product for balancing capacity from frequency restoration reserves **with manual and Direct Activation**; [...]

**Article 3 General principles - 2.** For each contracted standard mFRR balancing capacity product, each BSP shall provide corresponding capacity in the form of integrated scheduling process bids or standard mFRR balancing energy product bid(s), defined in the all TSOs’ proposal for the implementation framework for a European Platform for the exchange of balancing energy from mFRR pursuant to Article 20 of the EB Regulation. Such bids shall be direct activatable bids, provided that the delivery period does not exceed the end of the last validity period for which the BSP is contracted

There are two activation types, which the BSP can use when submitting an mFRR Energy Bid:

- **“Scheduled Activation only”**, meaning the bid can only be selected for an activation starting at the Point of Scheduled Activation (with a delivery in the concerned quarter-hour).
- **“Scheduled Activation and Direct Activation possible”**, meaning the bid can be selected for an activation starting at the Point of Scheduled Activation (with a delivery in the concerned quarter-hour), or for an activation starting during a 15-minute period starting at the Point of Scheduled Activation (with a delivery in two consecutive quarter-hours).

BSPs must indicate the activation type, taking into consideration the following rules:

- In line with the SPBC (article 3), for each quarter-hour, a BSP must submit contracted mFRR Energy Bid(s) available for both “Scheduled Activation and Direct Activation” for a volume that is equal to at least its concerned mFRR Obligation. However, in case the BSP’s mFRR Obligation for a CCTU is higher than the mFRR Obligation for the subsequent CCTU, the BSP is allowed to submit contracted mFRR Energy Bid(s) available for Scheduled Activation only for the last quarter-hour of the first CCTU. The maximum volume of contracted mFRR Energy Bid(s) offered for Scheduled Activation only, is less than or equal to the difference between the mFRR Obligations of both CCTUs.
- The “Scheduled Activation only” activation type may be used for a volume that, once activated, cannot be delivered for more than one quarter-hour (e.g., using limited energy resources). The limited duration of the activation would in this case also be indicated by using the bid characteristic for conditional linking.
- The “Scheduled Activation only” activation type may be used for a volume that is offered in the concerned quarter-hour but not in the consecutive quarter-hour (e.g. due to a change in the production schedule following a trade on the day-ahead or intraday market).
- The “Scheduled Activation only” activation type may be used in combination with the characteristic for conditional linking when it concerns an mFRR Energy Bid that is initially unavailable and, due to linking becomes available in case of activation of another bid for the previous quarter-hour (i.e. it concerns a consecutive activation for which continuity in the energy delivery can be guaranteed only via “Scheduled Activation” and not via “Direct Activation”).

#### 7.1.2.4. Maximum “bid volume”

The granularity of the offered volume is 1 MW and the minimum value for the offered volume is 1 MW.

The highest acceptable value for minimum bid volume is to be determined nationally. The highest acceptable value for (maximum) bid volume accepted on the mFRR-Platform is 9999 MW. This technical cap is, however, unacceptable for local system operations because it allows aggregations of volumes that would pose risks of congestion in case of activation or would result in an excessive quantity of mFRR Energy declared as unavailable (e.g. in the framework of the CRI filtering). ELIA sets therefore the highest acceptable bid volume as follows:

- For an mFRR Energy Bid with  $DP_{PG}$  the rules on volume apply per Providing Group. Per quarter-hour and direction, for a Providing Group including mFRR Energy Bids related to  $DP_{PG}$ , the following sum should be lower or equal to 100 MW:
  - The volume of the concerned mFRR Energy Bids, not included in an exclusive group and being not conditionally linked to another mFRR Energy Bid; and
  - The volume of the concerned mFRR Energy Bids being conditionally linked with another mFRR Energy Bid and considered as available by default for activation at the time of their submission to ELIA; and
  - For each concerned exclusive group, the maximum volume between the volumes of the concerned mFRR Energy Bids included in the exclusive group.
- For an upward (resp. downward) mFRR Energy Bid with a  $DP_{SU}$ , the maximum offered volume equals the sum of the  $DP_{mFRR,max,up}$  (resp.  $DP_{mFRR,max,down}$ ) of the each Delivery Point included in the mFRR Energy Bid.

For a Delivery Point  $DP_{SU}$ , the following values are determined as follows:

- the  $DP_{mFRR,max,up}$  is determined by  $DP\_Pmax_{inj}$ ,  $DP\_Pmax_{off}$  and  $DP\_Pmin_{inj}$  of the concerned  $DP_{SU}$ ;
- the  $DP_{mFRR,max,down}$  is determined by  $DP\_Pmax_{inj}$ ,  $DP\_Pmax_{off}$ , and  $DP\_Pmin_{off}$  of the concerned  $DP_{SU}$ .

An example of how to determine the  $DP_{mFRR,max,up}$  and  $DP_{mFRR,max,down}$  for a  $DP_{SU}$  can be found in the figure just below.

For each Delivery Point  $DP_{PG}$  connected to the ELIA Grid or to a CDS, the BSP declares itself the  $DP_{mFRR,max,up}$  and the  $DP_{mFRR,max,down}$ .

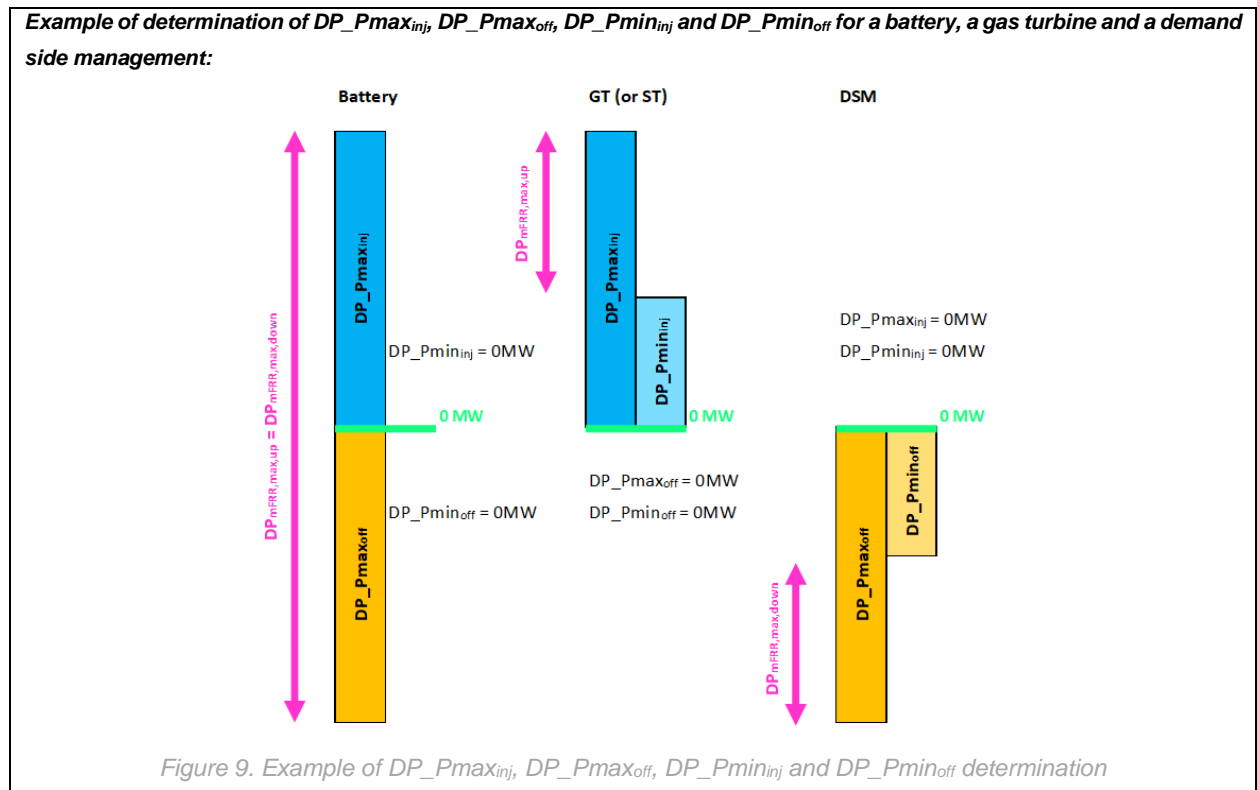

### 7.1.2.5. Minimum “bid volume” (Bid divisibility)

Important information no longer valid in the next design:

- mFRR Energy Bids are fully divisible or fully indivisible.
- The granularity of an mFRR Energy Bid is 0,1MW (starting from a minimum volume of 1MW).

#### mFRR IF definitions – Article 2

(e) ‘**divisible bid**’ means a standard mFRR balancing energy product bid, which can be activated partially in terms of power activation according to the bid activation granularity pursuant to Article 6(5) [of the mFRR IF];

(k) ‘**granularity**’ means the smallest increment in volume of a standard mFRR balancing energy product bid;

(l) ‘**indivisible bid**’ means a standard mFRR balancing energy product bid, which cannot be activated partially in terms of power activation according to the bid activation granularity pursuant to Article 7(2). Therefore, the volume of an indivisible bid is always activated altogether;

#### mFRR IF – Article 7

1. Minimum quantity = 1 MW / Maximum quantity = 9999 MW / Bid granularity = 1 MW

5. The maximum size of indivisible bids shall be defined in the national terms and conditions for balancing and shall not be higher than the largest technical minimum production or consumption of the pre-qualified generation or load unit of the BSP.

The “minimum bid volume” indicates whether the mFRR Energy Bid is fully divisible, partially divisible, or indivisible:

Minimum bid volume = 0 MW	Fully divisible	Any volume smaller than or equal to the offered volume can be activated
0 MW < Minimum bid volume < Offered bid volume	Partially divisible	Any volume, higher than or equal to the minimum bid volume can be activated
Minimum bid volume = Offered bid volume	Indivisible	Only the full offered volume can be activated

Table 6 List of characteristics of mFRR Energy Bids declared by ELIA

The granularity of the “minimum bid volume” is 1 MW and the minimum value for the “minimum bid volume” is 1 MW.

The following rules are applicable for upward mFRR Energy Bid including Delivery Points DP<sub>SU</sub>:

- When the Daily Schedule of a Delivery Point DP<sub>SU</sub> is superior or equal to its related DP<sub>Pmininj</sub>, this Delivery Point can only be included in a fully divisible mFRR Energy Bid;
- When the Daily Schedule of a Delivery Point DP<sub>SU</sub> is inferior to is DP<sub>Pmininj</sub>, this Delivery Point may be included in a (partially) indivisible mFRR Energy Bid. In other words, only non-started DP<sub>SU</sub> can be included in (partially) indivisible mFRR Energy Bids.

An mFRR Energy Bid including DP<sub>PG</sub> may be fully indivisible.

### 7.1.2.6. Price

<b>mFRR IF definitions – Article 7</b>
1. Price resolution: 0.01 €/MWh 3(a) price: in €/MWh 3(d) the <b>price</b> of the bid, be it positive, zero or negative, shall be defined in accordance with Table 1 of the EB Regulation;
<b>EBGL - Article 16 – Role of BSPs</b>
6.The price of the balancing energy bids or integrated scheduling process bids from standard and specific products pursuant to paragraph 4 shall not be predetermined in a contract for balancing capacity. A TSO may propose an exemption to this rule in the proposal for the terms and conditions related to balancing set-up pursuant to Article 18. Such an exemption shall only apply to specific products pursuant to Article 26(3)(b) and be accompanied with a justification demonstrating higher economic efficiency.
<b>Methodology for pricing balancing energy - Article 3 – General Principles</b>
3. The maximum price for all balancing energy product bids and the maximum value of the CBMP shall be 15,000 €/MWh. The minimum price for all balancing energy product bids and the minimum value of the CBMP shall be - 15,000 €/MWh <sup>29</sup> .

BSPs can offer mFRR Energy at a free (market-based) price, with a granularity of 0.01 €/MWh.

BSPs set the bid price taking into account the remuneration of activated mFRR Energy that is based on the “pay-as-clear” principle (see section 10.2 for a description on remuneration of activated mFRR Energy).

Until the first time ELIA connects to the mFRR-Platform (so between the mFRR Technical Go-Live and the connection to the mFRR-Platform):

<sup>29</sup> Note that these caps are only valid for 48 months starting from July 24, 2022, according to the “methodology for pricing balancing energy and cross-zonal capacity used for the exchange of balancing energy or operating the imbalance netting process, in accordance with Article 30(1) of Commission Regulation (EU) 2017/2195 establishing a guideline on electricity balancing of February 25, 2022. After this transition period, the maximum technical price limit shall be 99,999 €/MWh and the minimum technical price limit shall be - 99,999 €/MWh.

- The bid price must be inferior or equal to 13.500 €/MWh; and
- The bid price must be superior or equal to -13.500 €/MWh.

From the moment ELIA has connected to the mFRR-Platform or when ELIA is disconnected from the Platform in case of technical issue, the bid price must be in line with the “Methodology for pricing balancing energy and cross-zonal capacity used for the exchange of balancing energy or operating the imbalance netting process” established in accordance with EBGL art. 30(1).

### 7.1.2.7. Bid linking

#### 7.1.2.7.1. Parent-child group

Important information no longer valid in the next design: There are no rules on prices for parent-child bids (meaning, the price of the parent bid for upward mFRR can be higher than the price of the child bid).

#### mFRR IF definitions – Article 2

- (t) ‘**parent-child linking**’ is a type of economic linking, where a bid (the child) can only be activated if another specific bid (the parent) is activated as well, not vice-versa;
- (f) ‘**economic linking**’ means links between bids of a BSP with the purpose of economic optimization, allowing BSPs to offer more flexibility, to reflect efficiently their underlying cost structure in their offered bids, and to maximize the opportunity of being activated;

BSPs may for economic reasons want to indicate mFRR Energy Bids as being part of a so-called parent-child group<sup>30</sup>. A parent-child group refers to two or more mFRR Energy Bids submitted for the **same quarter-hour** that are associated as follows: **the bids that appear later in the merit order can only be selected for activation if the associated bids earlier in the merit order have been fully selected for activation.**

When submitting mFRR Energy Bids in a parent-child group, the BSP must respect the following rules (mainly coming from the mFRR-Platform):

- mFRR Energy Bids including Delivery Points DP<sub>SU</sub>, can be listed together in a parent-child group only in case they contain Delivery Points DP<sub>SU</sub> part of the same Technical Facility.
- An mFRR Energy Bid part of a parent-child group is not listed in an exclusive group.
- An mFRR Energy Bid is **only part of one parent-child group.**
- mFRR Energy Bids part of the same parent-child group may have different volumes.
- mFRR Energy Bids part of the same parent-child group **have different bid prices.** The mFRR-Platform cannot detect the parent-child group when the associated bids are ranked according to the same price in the merit order.
- mFRR Energy Bids part of the same parent-child group have the **same direction** and the **same activation type.**
- An mFRR Energy Bid part of a parent-child group has no conditional link with another mFRR Energy Bid.

---

<sup>30</sup> Note that in some implementation documents in the MARI project the term “multipart bids” is used as a synonym for bids in a parent-child group.

- ELIA is also responsible to set the **same availability status** to mFRR Energy Bids in a parent-child group when transmitting them to the mFRR-Platform. Indeed, from the moment one of the mFRR Energy Bids, contained in a parent-child group, has been set to unavailable for activation, then all the other mFRR Energy Bids part of this parent-child group must be set to unavailable for activation too.
- If at least one of the mFRR Energy Bids part of a parent-child group, is partially activated in Scheduled Activation or in Direct Activation, the remaining mFRR Energy Bids part of this parent-child group are no longer available for any subsequent Direct Activation.

**Example to detail the implications of the rule on the bid prices:**

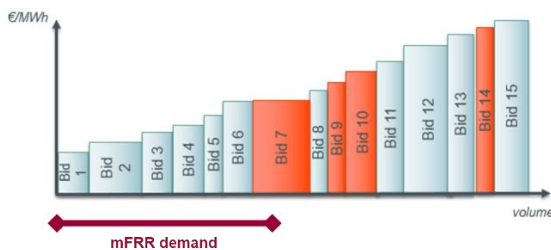

Figure 10. Upward mFRR Energy Bids in a parent-child group

**Assumptions:**

- Bids 7, 9, 10 and 14 are part of a same parent-child group;
- Bids 7, 9, 10 and 14 have different bid price;
- Bid 7 is an indivisible bid;
- Bids 9, 10 and 14 are divisible bids.

Considering the above-mentioned rules, the parent-child group will only have an impact when at least one of the bids part of the parent-child group is unforeseeably rejected (i.e., if a bid is not selected for activation although the bid price is lower than the Marginal Price).

As depicted in the figure above, the volume of bid 7 is larger than the remaining volume needed to cover the mFRR demand.

Therefore, bid 7 is not selected for activation.

Due to the parent-child group, bids 9, 10 and 14 become unavailable for activation. Consequently, it is possible that bid 8 is fully activated, bid 11 partially activated, and bids 7, 9 and 10 become unforeseeably rejected bids.

The rule on bid prices implies that the parent-child group cannot be used for cases including start-up costs that are higher than the price of the incremental energy after the start-up.

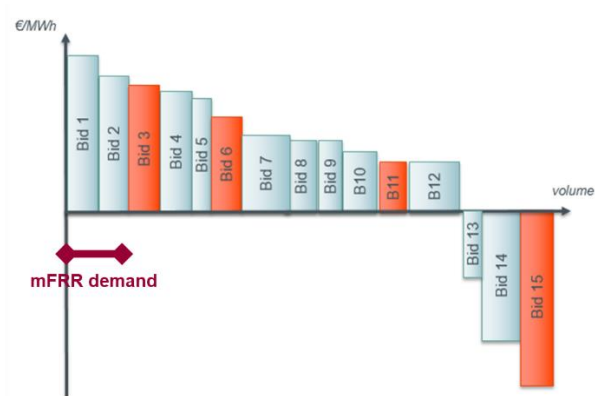

Figure 11. Downward mFRR Energy Bids in a parent-child group

**Assumptions:**

- Bids 3, 6, 11 and 15 are part of a same parent-child group;
- Bids 7, 9, 10 and 14 have different bid price;

Considering the above-mentioned rules, a parent-child group can be used to make the distinction between a downward mFRR Energy Bid without shut-down (e.g., to reduce the output to the minimum power  $DP_{P_{min,inj}}$ ) and a downward mFRR Energy Bid representing the shut-down.

In this example, bids 3, 6, 11 are downward mFRR Energy Bid without shut-down and bid 15 downward mFRR Energy Bid representing the shut-down (the costs associated to the shut-down lead to a negative price).

As depicted in the figure above, bids 3, 6 and 11 are not selected for activation. Therefore, in this case, the shut-down represented by bid 15 cannot be selected either.

**7.1.2.7.2. Exclusive groups**

**mFRR IF definitions – Article 2**

(i) ‘exclusive group order’ is a type of economic linking, where only one bid can be accepted from the list of bids part of the exclusive group order;

BSPs may for economic reasons want to associate mFRR Energy Bids submitted via a so-called exclusive group, meaning that only one bid in the group can be selected for activation in the same quarter-hour.

When submitting mFRR Energy Bids in an exclusive group, the BSP must respect some rules (mainly coming from the mFRR-Platform):

- mFRR Energy Bids including Delivery Points DP<sub>SU</sub>, can be listed together in an exclusive group only in case they contain Delivery Points DP<sub>SU</sub> part of the same Technical Facility.
- An mFRR Energy Bid part of an exclusive group is **not listed in a parent-child group**.
- An mFRR Energy Bid is **only part of one exclusive group**.
- mFRR Energy Bids part of the same exclusive group have the **same activation type**.
- An mFRR Energy Bid part of an exclusive group has **no conditional link** with another mFRR Energy Bid.
- There is a maximum number of exclusive groups per BSP: In order to guarantee a stable performance of the mFRR-platform, a limitation of the number of bids included in exclusive group is required. Each TSO connected to the platform receives a maximum number of exclusive groups, this number may evolve over time (a continuous monitoring is planned on the mFRR-Platform). When ELIA connects to the platform, ELIA assigns to each BSP the same maximum number of exclusive groups authorized per QH:  $\frac{\text{total number of exclusive groups per QH for ELIA}}{\text{number of BSPs in ELIA LFC Block}}$ . ELIA will also monitor the number of exclusive groups used locally.
- ELIA must set the **same availability status** for mFRR Energy Bids in an exclusive group when transmitting them to the European mFRR-Platform. Indeed, from the moment one of the mFRR Energy Bids part of an exclusive group has been set to unavailable for activation, then all the other mFRR Energy Bids submitted for the same quarter-hour, and part of the same exclusive group, are set to unavailable for activation too.

Exclusive groups can also be used to offer mFRR Energy in a “hierarchical” relation that does not respect the rules on the pricing of bids of parent-child groups. Exclusive groups can also be used to avoid the activation in the same quarter-hour of mFRR Energy Bids including same the Delivery Points in both the positive and the negative direction.

### 7.1.2.7.3. Technical (i.e., bid group) & conditional linking

<b>mFRR IF definitions – Article 2</b>
(bb) <b>‘technical linking’</b> means links between bids of a BSP in consecutive quarter-hours or in the same quarter-hour, needed to avoid the underlying asset performing unfeasible activations;

mFRR Energy Bids submitted by the BSP reflect the energy that is available for activation. However, the availability of a Delivery Point for a quarter-hour may depend on the actions taken in the preceding quarter-hour(s). The BSP may use the technical or the conditional link to reflect this dependency.

As depicted in Figure 12, at BE GCT for a quarter-hour QH(t<sub>0</sub>) the BSP is not aware of activations in the preceding quarter-hours QH<sub>-1</sub> and QH<sub>-2</sub>. At BE GCT for QH<sub>0</sub>, Scheduled Activations may still be requested for QH<sub>-1</sub> and Direct Activations may still be requested for both QH<sub>-1</sub> and QH<sub>-2</sub>. The BSP may offer the mFRR energy on the same Delivery Point(s) for all three quarter-hours and use the linking characteristic to indicate that the bid is no longer available if already activated in the quarter-hour(s) before, or alternatively, that a bid only becomes available in case of an activation in the preceding quarter-hour(s).



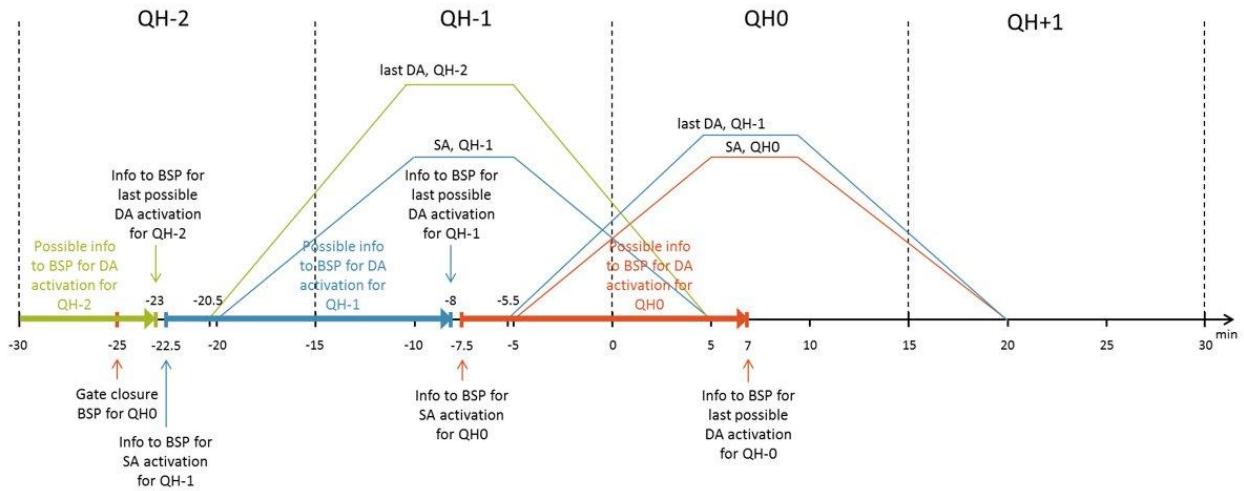

Figure 12. Timings for linking across consecutive quarter-hours.

The linking may, for example, be useful in case of Delivery Points with energy limitations or for demand response Delivery Points with limitations on duration or frequency of activations. This type of linking may also be used between positive and negative mFRR Energy Bids using the same Delivery Points if the switch between upward and downward activations is not technically feasible from one quarter-hour to another. Another use case concerns activations including start-up cost that would only need to be remunerated once: the BSP could submit a second bid without the start-up cost that would become available only in case of consecutive activation.

### Technical linking

Technical linking ensures that an mFRR Energy Bid submitted for the quarter-hour  $Qh_0$  and technically linked to an mFRR Energy Bid submitted for the quarter-hour  $Qh_{-1}$ , is marked as unavailable for activation in case the mFRR Energy Bid submitted for the quarter-hour  $Qh_{-1}$  is (partially) activated in Direct Activation.

The BSP may technically link two mFRR Energy Bids by listing them in the same bid group in case the following conditions simultaneously applies:

- All mFRR Energy Bids listed in a same bid group have the same direction;
- Only one mFRR Energy Bid is submitted per bid group and quarter-hour.

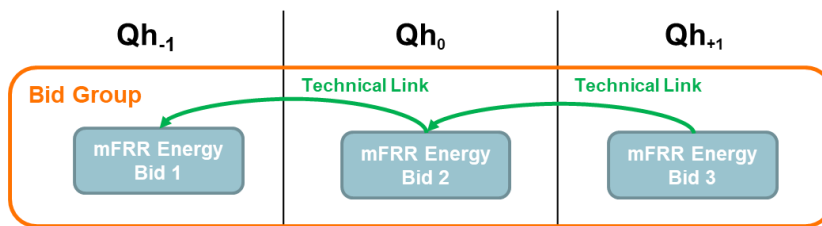

Figure 13: Illustration of a bid group

An mFRR Energy Bid, submitted for a quarter-hour  $Qh_0$ , can be included in both a bid group and an exclusive (or parent-child) group. In such a case, all mFRR Energy Bids submitted for the quarter-hour  $Qh_0$  and included in the exclusive (or parent-child) group, will be automatically technically linked to the mFRR Energy Bids submitted for the quarter-hour  $Qh_{-1}$  and part of the same exclusive (or parent-child) group.

**Example:**

- **Step 1:** mFRR Energy Bid 1 (submitted for quarter-hour  $Qh_{-1}$ ) is activated in Direct Activation;

- **Step 2:** mFRR Energy Bid 2 (submitted for quarter-hour  $Qh_0$ ) is set to unavailable because of its technical link with mFRR Energy Bid 1;
- **Step 3:** mFRR Energy Bids 5 and 8 (submitted for the quarter-hour  $Qh_0$ ) are set to unavailable for activation because there are part of the same exclusive group as mFRR Energy Bid 2.

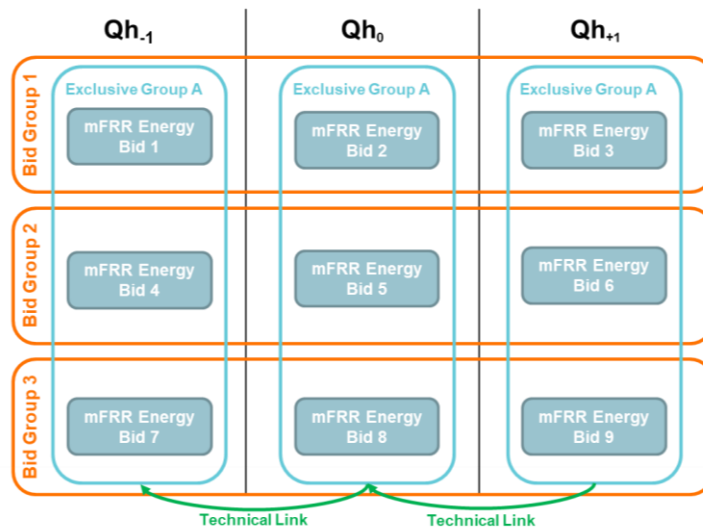

Figure 14: Illustration of a combination between a bid group and an exclusive group

The BSP may choose to combine multiple bid groups in the same mFRR Providing Group under the conditions that:

- mFRR Energy Bids listed in a same bid group are part of the same mFRR Providing Group.
- mFRR Energy Bids listed in a parent-child group are part of the same mFRR Providing Group.
- Per quarter-hour, a Delivery Point listed in an mFRR Energy Bid of an mFRR Providing Group is not also listed in an mFRR Energy Bid of another mFRR Providing Group (in other words, per quarter-hour, a Delivery Point can exclusively be used in one mFRR Providing Group).
- Per quarter-hour, mFRR Energy Bids related to a Delivery Point  $DP_{SU}$  are not listed together in an mFRR Providing Group in case they contain Delivery Points  $DP_{SU}$  of different Technical Facilities.

### Conditional linking

As defined in Table 7 and Table 8, there are several types of conditional linking. The BSP may conditionally link the availability or the unavailability for activation of an mFRR Energy Bid to the activation or the non-activation of another mFRR Energy Bid by linking the two bids together in case the following conditions simultaneously applies:

- An mFRR Energy Bid of quarter-hour  $Qh_0$  is only conditionally linked to mFRR Energy Bids of quarter-hour  $Qh_{-1}$  and/or  $Qh_{-2}$ ;
- An mFRR Energy Bid of quarter-hour  $Qh_0$  has conditional links with a maximum of 3 different mFRR Energy Bids of quarter-hour  $Qh_{-1}$ <sup>31</sup> and 3 of quarter-hour  $Qh_{-2}$ ;
- There can only be one conditional link between two mFRR Energy Bids;
- Two mFRR Energy Bids including Delivery Points  $DP_{SU}$ , can be conditionally linked together only in case they contain Delivery Points  $DP_{SU}$  part of the same Technical Facility;
- An mFRR Energy Bid is not conditionally available and conditionally unavailable (i.e. an mFRR Energy Bid does not combine a conditional link of Table 7 with a conditional link of Table 8);

Conditional link	Description
Type 1	Bid becomes <b>unavailable</b> if the linked bid is activated (in either Scheduled Activation or Direct Activation)

<sup>31</sup> There is no limit to the number of mFRR Energy Bids in the quarter-hour  $Qh_0$  that a given mFRR Energy Bid submitted in quarter-hour  $Qh_{-1}$  or quarter-hour  $Qh_{-2}$  might influence. Nonetheless, it remains the responsibility of the BSP to ensure that the conditional linking rules reflect the actual technical availabilities of the underlying assets for activation.

Type 2	Bid becomes <b>unavailable</b> if the linked bid is not activated
Type 3	Bid becomes <b>unavailable</b> if the linked bid is activated in Scheduled Activation
Type 4	Bid becomes <b>unavailable</b> if the linked bid is activated in Direct Activation
Type 5	Bid becomes <b>unavailable for Direct Activation</b> if the linked bid is activated in Direct Activation
Type 6	Bid becomes <b>unavailable for Direct Activation</b> if the linked bid is activated in Scheduled Activation

Table 7. Conditional linking: options for linking of bids across consecutive quarter-hours

Conditional link	Description
Type A	Bid becomes <b>available</b> if the linked bid is activated (in either Scheduled Activation or Direct Activation)
Type B	Bid becomes <b>available</b> if the linked bid is not activated
Type C	Bid becomes <b>available</b> if the linked bid is activated in Scheduled Activation
Type D	Bid becomes <b>available</b> if the linked bid is activated in Direct Activation
Type E	Bid becomes <b>available for Direct Activation</b> if the linked bid is activated in Direct Activation
Type F	Bid becomes <b>available for Direct Activation</b> if the linked bid is activated in Scheduled Activation

Table 8. Conditional linking: options for linking of bids across consecutive quarter-hours

- An mFRR Energy Bid of quarter-hour Qh<sub>0</sub> conditionally linked to another mFRR Energy Bid of quarter-hour Qh<sub>1</sub> or Qh<sub>2</sub>, is not listed in a parent-child group or in an exclusive group;
- Considering the technical character of this bid characteristic, conditional linking may only be used between mFRR Energy Bids submitted to ELIA if the Delivery Points in the bids are part of the same Providing Group.

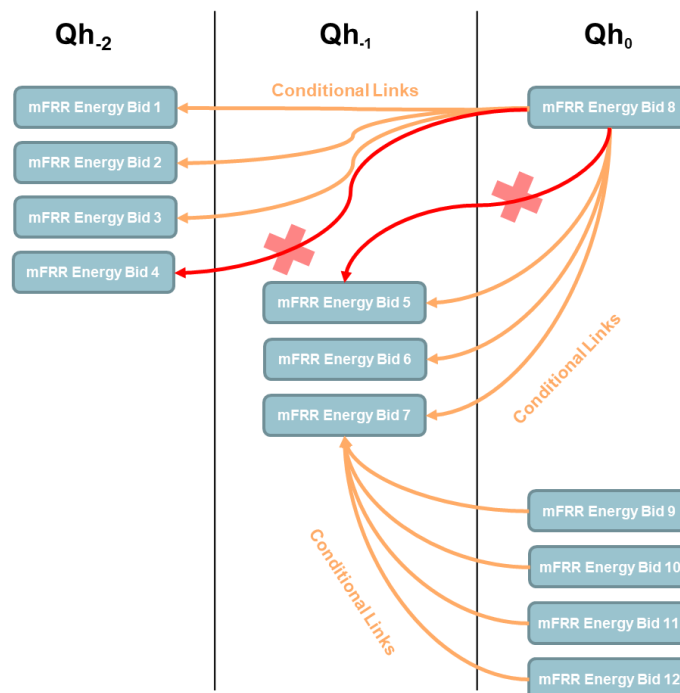
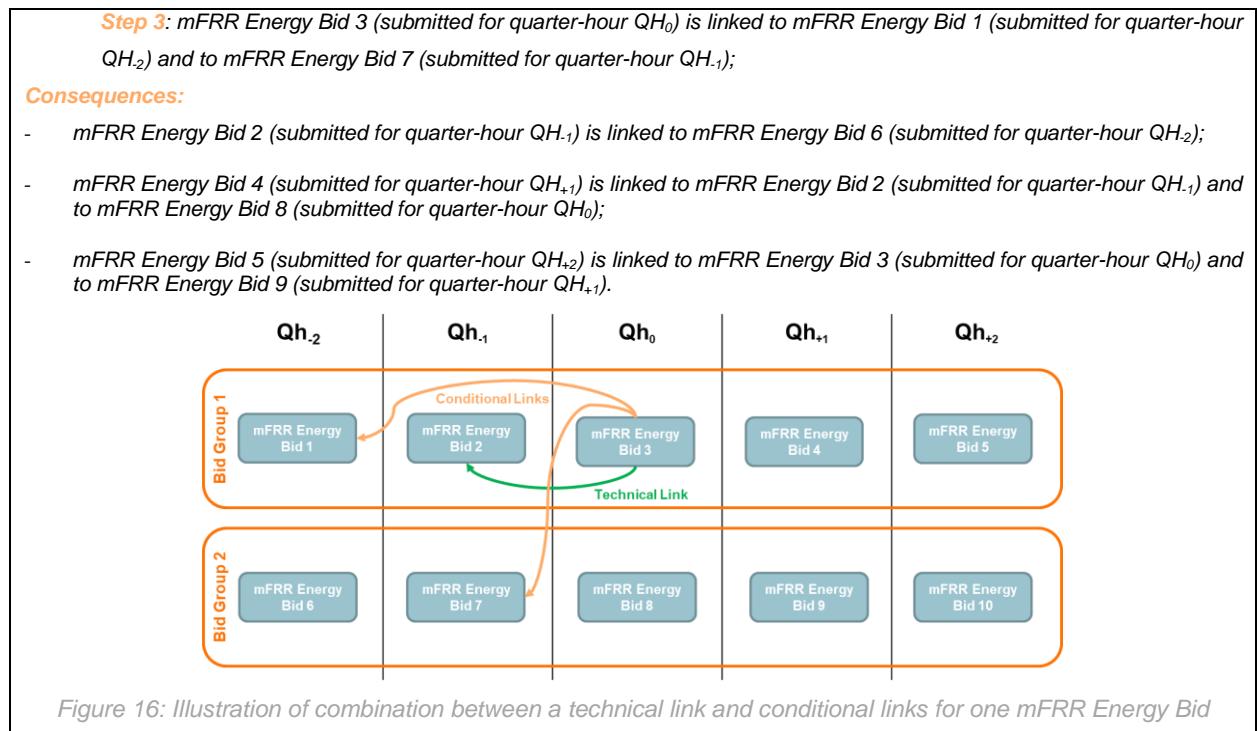

Figure 15: Illustration of allowed and not-allowed conditional links

An mFRR Energy Bid can be included in a bid group and have a conditional link with an mFRR Energy Bid, part of the same (or another) bid group. In such a case, the same conditional link will apply for all the mFRR Energy Bids part of this (or these) bid group(s):

**Example:**

- Step 1:** mFRR Energy Bids 1, 2, 3, 4 and 5 are included in bid group 1;
- Step 2:** mFRR Energy Bids 6, 7, 8, 9 and 10 are included in bid group 2;



#### 7.1.2.7.4. Combination of bids linking

The final availability of an mFRR Energy Bid for Scheduled Activation and/or Direct Activation may potentially be influenced by its dependencies to other mFRR Energy Bid(s) to which it is technically or conditionally linked. If an mFRR Energy Bid is subject to both conditional and technical linking and those links would yield different availability status, then the mFRR Energy Bid will be marked as unavailable for activation.

#### 7.1.2.8. BSP Facilitation

As already said in section 6.2, discussions are ongoing regarding the BSP Facilitation topic<sup>32</sup>. For now, it has been agreed that the BSP may, at the BSP’s discretion, submit an mFRR Energy Bid with a Maximum Activation Time and/or a Neutralization Time. The details regarding these functionalities will be sent to the market parties in Q4 of 2023.

#### 7.1.2.9. List of Delivery Points

For each quarter-hour, the BSP may choose which Delivery Points part of the Pool are included in the mFRR Energy Bid, while complying with the following conditions:

- DP<sub>PG</sub> (i.e., Technical Units located within the Elia LFC Block for which Elia does not receive a Daily Schedule) may be grouped in one mFRR Energy Bid. The DP<sub>PG</sub>
- DP<sub>SU</sub> may be aggregated in an mFRR Energy Bid as long as all the DP<sub>SU</sub> in the mFRR Energy Bid belong to the same Technical Facility. The mFRR Energy Bid allows the BSP to offer the energy depending on the Operating Mode on day D<sup>33</sup>, or taking into account switches between Operating Modes that are feasible within

<sup>32</sup> Cf. the workshop organized with the market parties on July 7, 2023.

<sup>33</sup> For example, if a CCGT cannot be operated in CCGT mode on one of the two gas turbines (Operating Mode), then a ‘half CCGT mode’ will not be a technically feasible Operating Mode for that Technical Facility.

the Full Activation Time of mFRR. Consequently, the same DP<sub>SU</sub> can be included in more than one mFRR Energy Bid: multiple mFRR Energy Bids including the same DP<sub>SU</sub> can either represent different volumes offered at different conditions, or the same volume offered at different conditions and grouped or linked to avoid simultaneous activation<sup>34</sup>.

#### 7.1.2.10. Link with an mFRR Obligation

SOGL – Article 16
4. Each BSP with a contract for balancing capacity shall submit to its connecting TSO the balancing energy bids or integrated scheduling process bids corresponding to the volume, products, and other requirements set out in the balancing capacity contract.
5. Any BSP shall have the right to submit to its connecting TSO the balancing energy bids from standard products or specific products or integrated scheduling process bids for which it has passed the prequalification process pursuant to Article 159 and Article 162 of Regulation (EU) 2017/1485.
7. There shall be no discrimination between balancing energy bids or integrated scheduling process bids submitted pursuant to paragraph 4 and balancing energy bids or integrated scheduling process bids submitted pursuant to paragraph 5.

BSPs must indicate whether an mFRR Energy Bid serves to respect an mFRR Obligation. The distinction is important to organize the availability tests (see section 11.1), to track the update requests to modify bid volumes after BE GCT (see section 7.4).

ELIA has no capacity product for downward activation. Therefore, BSPs offer all negative energy as “non-contracted mFRR”.

BSPs offer positive mFRR Energy Bids as “non-contracted mFRR” or as “contracted mFRR”.

## 7.2. Supporting mFRR Providing Group

In addition to mFRR Energy Bids, the BSP will be able to submit a Supporting mFRR Providing Group for each quarter-hour. This Providing Group may include any DP that is already included in an mFRR Energy Bid for the concerned quarter-hour as well as any other DP part of the BSP’s Pool but not yet included in an mFRR Energy Bid.

The DPs in this providing group are subject to the rules on combinability of mFRR with aFRR: no DP<sub>PG</sub> that is used in an aFRR Energy Bid may be included in a Supporting mFRR Providing Group for the same quarter-hour.

The DPs in this providing group are also subject to CRI filtering (see section 7.5.1), this means that only DP located in a zone with a low level of congestion risk can be included in a Supporting mFRR Providing Group.

## 7.3. Baseline for activation

The BSP offers mFRR energy that can be provided on the Delivery Point in comparison to a reference power level. This reference power is the Baseline. The Baseline is important to verify the delivery of the mFRR Power: ELIA calculates the mFRR Supplied (used in the activation control, see 11.2) on a Delivery Point by making the difference between the Baseline and the measured power.

The Baseline for a Delivery Point DP<sub>SU</sub> is the **Daily Schedule** communicated by the Scheduling Agent and used by ELIA in all the processes described in the SA Contract. As section 7.4, in the framework of an mFRR Energy Bid

<sup>34</sup> By using characteristics such as exclusivity groups in the same quarter-hour or conditional linking in consecutive quarter-hours.

update, the Baseline of a DP<sub>SU</sub> can be updated so that it corresponds to the “new Daily Schedule” submitted by the BSP to ELIA in the context of the BSP Contract mFRR.

The Baseline for a Delivery Point DP<sub>PG</sub> can be one of the following (chosen by the BSP):

- **High X of Y** Baseline, i.e., the reference power calculated based on the measurements of a selection of days that are considered as representative for the day on which the concerned activation occurs.
- **Last quarter-hour** Baseline, i.e., the power measured during the last quarter-hour that preceded an mFRR activation request and that was not subject to a previously requested full delivery of mFRR power (see Figure 17 A). In this last case of closely following activations, the Baseline of the 1<sup>st</sup> activation request will continue to be used (see Figure 17 B & C). However, the last quarter-hour used as Baseline may include the end of an mFRR deactivation period (see Figure 17 D).

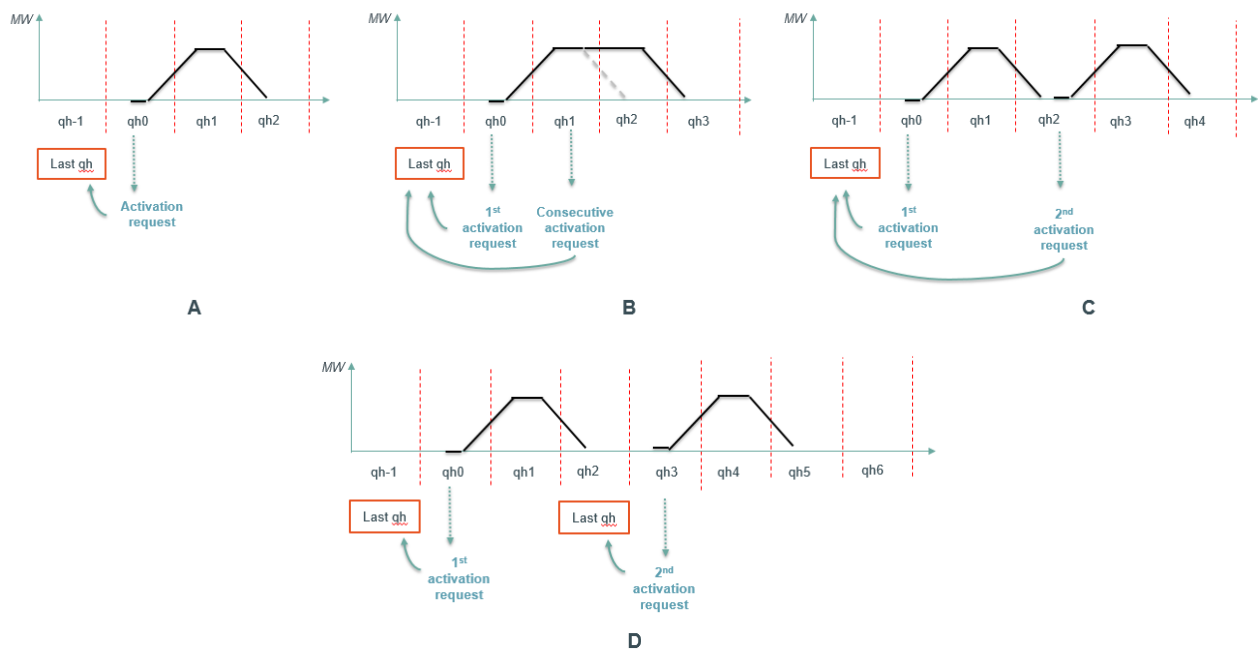

Figure 17. Cases of determination of the last quarter-hour Baseline

## 7.4. Update of mFRR Energy Bid by the BSP after BE GCT

### mFRR Energy Bid update after BE GCT

ELIA will facilitate reductions of the bid volume after BE GCT for a limited set of reasons.

As of mFRR Balancing GCT and until 5 minutes after the start of the quarter-hour for which an mFRR Energy Bid was submitted or until an activation request has been received by the BSP for the mFRR Energy Bid (whichever occurs first), the BSP can submit a request to decrease the volume of its mFRR Energy Bid under the following circumstances:

- **In case a partial or full Forced Outage** of a Delivery Point affects the bid volume of a contracted or non-contracted mFRR Energy Bid, the BSP must request to decrease the bid volume for the quarter-hours for which the Forced Outage applies. Please note that, whether or not the BE GCT has passed, as soon as the BSP notices a Forced Outage leading to an unfeasible delivery of the volume offered in its mFRR Energy Bid(s), the BSP is obligated to submit an update of its impacted mFRR Energy Bid(s) with a decreased volume. This obligation should be understood as a best-efforts obligation.

- In case a **Redispatching Energy Bid is activated by ELIA** and the concerned redispatching requested energy is provided by a DP<sub>SU</sub> which is also included in a non-contracted mFRR Energy Bid, the BSP must request to decrease the bid volume for the quarter-hours concerned by this redispatching activation. The SA is then able to confirm the Operating Mode of the DP<sub>SU</sub> if any, and the BSP notifies ELIA as soon as possible of the decrease of the mFRR Energy Bid volume.
- The BSP can submit a request to decrease the volume of its non-contracted upwards mFRR Energy Bid (respectively downwards):
  - in case the BSP has a firm intention, at the moment of the request, to dispatch one or several Delivery Point(s), part of that non-contracted upwards mFRR Energy Bid (respectively downwards), to balance the perimeter of the concerned BRP (i.e., for **self-balancing**), balance the ELIA LFC Block (i.e., for **reactive balancing**) or perform a **trade on the intraday** market; and
  - The non-contracted upwards (respectively downwards) mFRR Energy Bid does not contain any Delivery Point included in a zone with a Medium Level of CRI in the upward (respectively downward) direction or a High Level of CRI in the upward (respectively downward) direction.

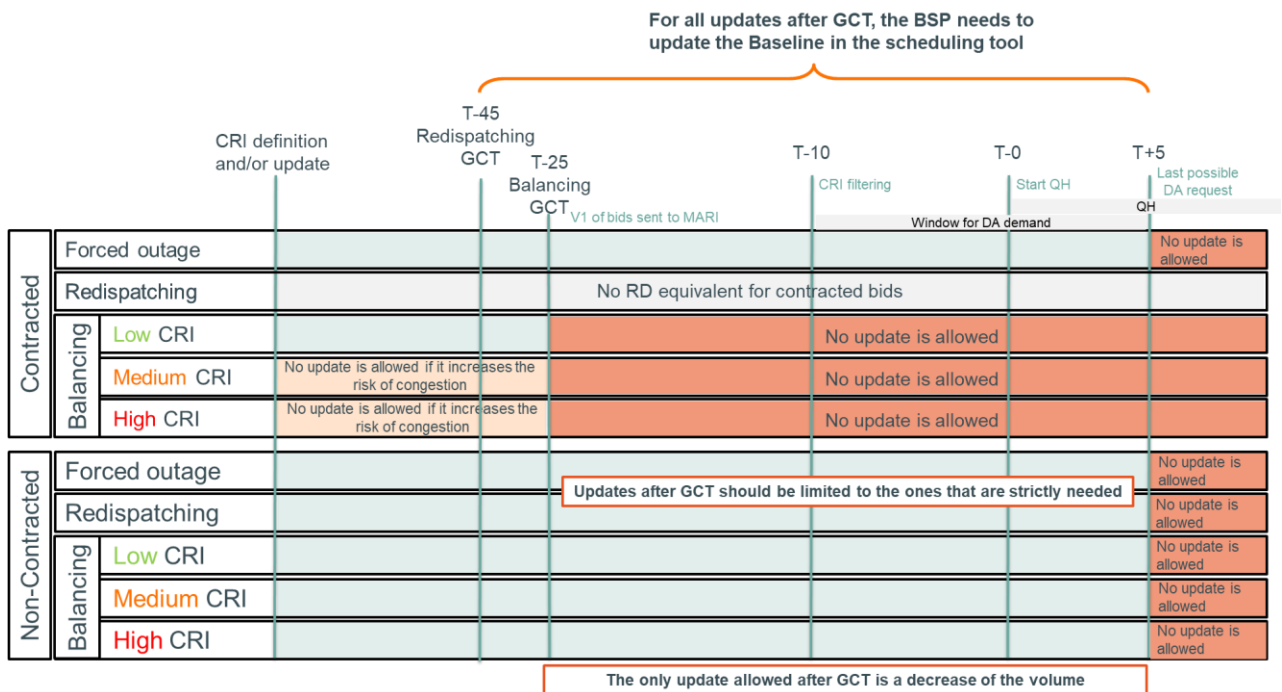

Figure 18. Rules for the mFRR Energy Bid update after BE GCT

In the case of an mFRR Energy Bid update after BE GCT, the BSP must notify ELIA of a volume decrease with the reason of this modification. Afterwards ELIA will transmit the change to the platform. However, once the concerned updated bids are included as input in an optimization run of the mFRR-Platform (AOF), they can no longer be modified and may be selected for activation without taking the update into account. To avoid any problem for the BSP, ELIA will always take the latest version of the mFRR Energy Bid for all activation requests.

In case a BSP request a reduction of the volume of an mFRR Energy Bid to 0 MW, ELIA will translate this as a status “unavailable” for the mFRR-Platform (as the minimum value for bid volume is 1 MW).

### Baseline update after Redispatching GCT

In case the BSP updates (and is allowed to do so, according to the rules set out above) a non-contracted energy bid mFRR Energy Bid related to a Delivery Point DP<sub>SU</sub> after the RD GCT of the quarter-hour for which the concerned mFRR

Energy Bid was submitted, it must ensure that the Baseline of each Delivery Point DPSU included in this mFRR Energy Bid, is updated accordingly.

In such a case, a BSP has the possibility to update the Baseline of a Delivery Point DPSU included in an mFRR Energy Bid:

- from the RD GCT related to the quarter-hour for which the mFRR Energy Bid was submitted; and
- until 5 minutes after the start of the quarter-hour for which the mFRR Energy Bid was submitted or until the Delivery Point has been listed in the acknowledgement messages, as per Annex 10.A, sent by the BSP to ELIA; and
- if the following conditions are met:
  - The BSP has a firm intention, at the moment of the request, to actually dispatch its Delivery Point to balance the perimeter of the concerned BRP (i.e., for self-balancing), balance the ELIA LFC Block (i.e., for reactive balancing) or perform a trade on the intraday market; and
  - Once the levels of CRI are identified and communicated to the BSP, the Baseline update is not made in the upward (respectively downward) direction when the concerned Delivery Point DPSU belongs to an Electrical Zone with a Medium Level of CRI or a High Level of CRI in the upward (respectively downward) direction.

By doing so, the BSP can avoid unjustified penalties in the activation control where the Daily Schedule is used as a reference to determine whether the mFRR Supplied complies with the mFRR Requested (as explained in section 11.2.1).

The Baseline, updated in the framework of an mFRR Energy Bid update after RD GCT, does not replace in any way, the Daily Schedule communicated by the Scheduling Agent and used by ELIA in all the processes described in the SA Contract. The sole purpose of this update is for the BSP to have a correct Baseline for the mFRR activation control.

## 7.5. Bids modification by ELIA

<b>mFRR IF Article 2 – Definitions</b>
(a) <b>‘availability status’</b> means the condition of a bid being available or unavailable for cross-border activation pursuant to Article 29(9) and (14) of the EB Regulation;
<b>EBGL - Article 29 - Activation of balancing energy bids from common merit order list</b>
14. Each TSO may declare the balancing energy bids submitted to the activation optimization function unavailable for the activation by other TSOs because they are restricted due to internal congestion or due to operational security constraints within the connecting TSO scheduling area.
<b>Federal Grid Code – Article 227</b>
De transmissienetbeheerder ziet toe op de beschikbaarheid van en, in voorkomend geval, op de inwerkingstelling van de balanceringsdiensten: 1° volgens objectieve, transparante en niet-discriminerende procedures, die berusten op de marktregels overeenkomstig artikel 4 van de Europese richtsnoeren EBGL; en 2° overeenkomstig de operationele regels voorzien in dit besluit. / Le gestionnaire de réseau de transport veille à la disponibilité et, le cas échéant, met en place les services d'équilibrage : 1° selon des procédures objectives, transparentes, non discriminatoires, et reposant sur les règles du marché conformément à l'article 4 de la ligne directrice européenne EBGL ; et 2° conformément aux règles opérationnelles prescrites dans le présent arrêté.
Electricity Law – article 8
(§ 1.) Het beheer van het transmissienet wordt waargenomen door één enkele beheerder, [...] Hiertoe wordt de netbeheerder onder meer met de volgende taken belast: [...] 2° zorgen voor een zeker, betrouwbaar en efficiënt elektriciteitsnet en er in dit verband op toe zien dat de



nodige ondersteunende diensten beschikbaar zijn en geïmplementeerd worden, voor zover die beschikbaarheid onafhankelijk is van ieder ander transmissienet waaraan zijn systeem gekoppeld is. De ondersteunende diensten omvatten met name de diensten die worden verleend als reactie op de vraag [met inbegrip van de activering van de vraagflexibiliteit] en hulpdiensten in geval van uitvallen van productie-eenheden, hierbij inbegrepen eenheden gebaseerd op hernieuwbare energieën en kwalitatieve warmtekrachtkoppeling. Voor de activering van de productiemiddelen [en de vraagflexibiliteit] die noodzakelijk zijn om het evenwicht van de regelzone te verzekeren geeft de netbeheerder voorrang aan het gebruik van een transparant marktplatform.

ELIA must transmit all mFRR Energy Bids submitted by the BSP to the mFRR-Platform. However, ELIA can also, in accordance with EBGL (articles 12 and 29) and the mFRR IF (article 9), declare mFRR Energy Bids as unavailable for activation on the mFRR-Platform and transparently report on such bid unavailability.

ELIA can declare an mFRR Energy Bid as unavailable for selection for activation by the mFRR-Platform for different reasons. The unavailability may be general or apply to a particular activation type. An unavailability for the mFRR-Platform does not necessarily mean that the bid is unavailable for activation by ELIA locally. The following paragraphs explain why and how ELIA modifies the availability status of the bids.

Reason	Impact on local use	mFRR-Platform availability status
Restrictions due to internal congestion (CRI filtering) <i>Cf. section 7.5.1</i>	Bid is unavailable for local use	Bid is unavailable
Local activation of an mFRR Energy Bid for purpose of redispatching <i>Cf. section 7.5.2</i>	Bid is activated locally	Bid is unavailable
Execution of an mFRR availability test <i>Cf. section 7.5.2</i>	Bid is activated locally	Bid is unavailable
Guaranteed Volume <i>Cf. section 7.5.3</i>	No impact on possibilities for local use	Bid is unavailable for SA but available for DA via the mFRR-Platform
Erroneous mFRR Energy Bid <i>Cf. section 7.5.3</i>	Bid is unavailable for local use	Bid is unavailable

Table 9. Possibilities of modification of bid availability status by ELIA

ELIA sets the availability status of the mFRR Energy Bids after BE GCT but before transmitting the bids to the mFRR-Platform by 12 minutes before the start of the concerned quarter-hour. If new information becomes available afterwards, ELIA may still modify the availability status on the mFRR-Platform. However, the mFRR-Platform will only take into consideration the updated values for the optimization runs that start afterwards.

### 7.5.1. Avoiding mFRR activation due to internal congestion risks

As part of congestion management, ELIA avoids activating energy for balancing purpose in Electrical Zones that may create or aggravate a congestion risk. To this aim, ELIA would declare an mFRR Energy Bid as unavailable for both local and European activation.

ELIA monitors congestion risks in Electrical Zones using the **Congestion Risk Indicator (“CRI”)**: As described in Rules for Coordination and Congestion Management and summarized in Figure 19, it indicates the risks of congestion per Electrical Zone due to changes in injection or offtake of Delivery Point.

**There are 3 levels of CRI:**

Low CRI	No congestion are forecasted MW cap = ∞ → All increases of production (resp. decrease) are tolerated by the grid
Medium CRI	N-1 violation > 100% in case of incr./decr. of production in the zone MW cap > 0 → Only a volume of MW Cap of increase of production (resp. decrease) is tolerated by the grid
High CRI	N-1 violation > 100% with most updated forecasts / schedules MW cap = 0 MW → No increase of production (resp. decrease) is tolerated by the grid

**These levels of CRI are determined:**

... for a direction	Upward Downward Both upward and downward
... for a specific duration	Hourly granularity
... for an electrical zone	<ul style="list-style-type: none"> <li>• 380kV</li> <li>• Langerbrugge West</li> <li>• Langerbrugge East</li> <li>• Brussels / Schaerbeek</li> <li>• Merkssem</li> <li>• Liège</li> <li>• Stalen</li> <li>• Ruien</li> <li>• Hainaut West</li> <li>• Hainaut East</li> </ul>

Figure 19. CRI levels

When a Delivery Point that is part of a congestion-prone Electrical Zones, is included in one (or more) mFRR Energy Bid(s), ELIA needs to assess whether this(these) bid(s) must be declared as unavailable for activation, depending on whether the activation of this(these) bids present(s) a potential congestion risk.

If, before mFRR Balancing GCT, ELIA sets an Electrical Zone with a Medium Level of CRI or a High Level of CRI which concerns a Delivery Point included in an mFRR Energy Bid, the BSP receives an electronic message to indicate that the concerned mFRR Energy Bid **may be considered as unavailable** for activation. **ELIA expects a best effort from the BSP to update its concerned bids** (and if applicable, shift the mFRR Obligation) **before BE GCT** to render as much volume as possible available for activation. No bid updates before BE GCT will be allowed that would lead to a smaller volume being available for activation based on the information on DP usability and impact on bid availability known at that moment.

A BSP may update a bid that include a mix of both usable and non-usable Delivery Point by removing the non-usable DP from the bid (which is an easy solution if no impact on offered volume). In case the Delivery Point's non-usability implies that the BSP could no longer offer the entire bid volume (even though, for example, the BSP is obliged to do so because it has an mFRR Obligation), the BSP may split the volume in two separate bids (one including only the usable Delivery Point and one including only the non-usable Delivery Point) in order to ensure that no volume is declared unnecessarily as unavailable.

The CRI level would affect the usability of DP included in mFRR Energy Bids as follows:

Low CRI	The DPs in the concerned Electrical Zone will be usable for balancing → The associated mFRR Energy Bids <b>remain</b> available for balancing
Medium CRI	The DPs in the concerned Electrical Zone may become non-usable for balancing → The associated mFRR Energy Bids <b>would be</b> unavailable for balancing <i>Before the final levels of CRI are known, ELIA cannot give more concrete information to the BSP on the usability of the DP as this would imply giving premature information on the merit order of the bids</i>
High CRI	The DPs in the concerned Electrical Zone will be non-usable → The associated mFRR Energy Bids <b>will be</b> unavailable for balancing

Figure 20. Effects of the CRI levels on an mFRR Energy Bid

The **final CRI levels** and therefore the final impact on the bid availability (i.e., the CRI filtering) will only be determined and communicated 10 minutes before the start of the concerned quarter-hour. Before that time ELIA still publishes the indicative CRI levels as important information for the BSP to take into account in the bidding process.

The Delivery point usability will affect the **availability status of an mFRR Energy Bid** as follows:

- An mFRR Energy Bid including **only usable DP** will remain **available**;
- An mFRR Energy Bid including **one or more non-usable DP** will become **unavailable**.

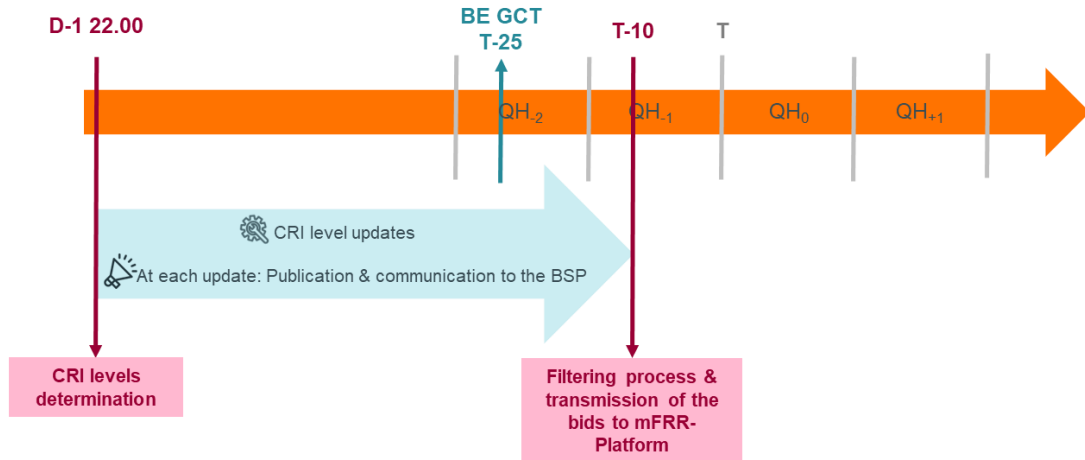

Figure 21. Timeline for the CRI filtering

### Filtering of mFRR Energy Bids including DP in an Electrical Zone with a High Level of CRI

In an Electrical Zone with a High Level of CRI, it is not allowed to activate mFRR Energy Bids in the direction of the congestion and all mFRR Energy Bids having a Delivery Point in the Electrical Zone will be automatically filtered and rendered unavailable for activation for the concerned quarter-hour.

### Filtering of mFRR Energy Bids including DP in an Electrical Zone with a Medium Level of CRI

For each Electrical Zone with a Medium Level of CRI, ELIA determines a volume of MW (also known as “MW cap”<sup>35</sup> volume or the “Zonal Active Power Cap”) which will be used for the filtering of mFRR Energy Bids. **The balancing activations in the concerned Electrical Zone(s), either for upward or downward activations depending on the direction of the congestion, must respect this “MW cap”**. It means that ELIA will assess the volume of received mFRR Energy Bids compared to the “MW cap” volume and if needed, apply a filtering on some mFRR Energy Bids, making them unavailable for activation.

In an Electrical Zone with a Medium Level of CRI, mFRR Energy Bids are automatically filtered as follows:

- Starting from the value of the “MW Cap” as determined in the Rules for Coordination and Congestion Management, ELIA determines the **effective “MW Cap”** for the Electrical Zone and per quarter-hour by considering the available volume of aFRR Energy Bids (ELIA gives priority to aFRR Energy Bids compared to mFRR Energy Bids) in the concerned direction and the netted volume of mFRR Energy Bids activated in Direct Activation in the previous quarter-hour (cf. Figure 22).

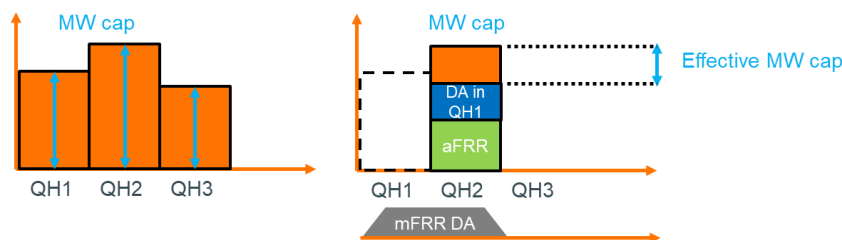

Figure 22. Timeline for the CRI filtering

<sup>35</sup> More information regarding the “MW cap” determination can be found in the Rules for Coordination and Congestion Management.

- In case an mFRR Energy Bid is offered for Direct Activation, the effective “MW Cap” for the consecutive quarter-hour of the Direct Activation also needs to be considered in the filtering:

$$\min\{effective\ MW\ Cap_{QH};\ effective\ MW\ Cap_{QH+1}\}$$

- Only the mFRR Energy Bids that are not marked as unavailable for the quarter-hour for other reasons than grid security and as part of congestion management, are considered in the filtering. As a pre-treatment in the filtering process of balancing bids, ELIA will first filter out the mFRR Energy Bids that are already declared as unavailable due to linking or activations in the previous quarter-hour (cf. section 7.1.2.7).
- ELIA follows the LMOL for mFRR considering the above, in the direction of the congestion, until the effective “MW Cap” or the effective “MW Cap” for Direct Activation, depending on the activation type, is reached to allow this selection of mFRR Energy Bids to participate to the balancing market. The other mFRR Energy bids above the Cap are withheld by ELIA.

After filtering, the mFRR Energy Bids not withheld by ELIA according to the above, are available for activation. On the other hand, the filtered mFRR Energy Bids are unavailable for activation. If it is connected to the mFRR-Platform, ELIA sends the LMOL for mFRR with updated availability status due to the CRI filtering process to the mFRR-Platform.

### Supporting mFRR Providing Group

At the latest at mFRR Balancing GCT, the BSP is informed of all Delivery Points, listed in a Supporting mFRR Providing Group, that are impacted by a Medium Level of CRI or a High Level of CRI.

**Per quarter-hour and per direction, the Delivery Points located in an Electrical Zone with a Low Level of CRI can be part of the concerned Supporting mFRR Providing Group**, while the Delivery Points located in an Electrical Zone with a Medium Level of CRI or a High Level of CRI cannot.

### 7.5.2. Avoiding double activation

There are two cases in which ELIA can activate energy offered in an mFRR Energy Bid for other purposes. Therefore, ELIA needs to be able to declare the concerned mFRR Energy Bid as unavailable for activation for the mFRR-Platform:

- As elaborated in section 1.1.2, ELIA may activate mFRR Energy Bids as a **remedial action to solve a specific congestion risk**. ELIA will therefore have to declare the concerned mFRR Energy Bid as unavailable for activation via the mFRR-Platform, but nonetheless activate it locally in respect of the BSP Contract mFRR.
- As described in section 11.1, ELIA may activate mFRR Energy Bids by surprise for the purpose of an **mFRR availability test**. As the activated energy does not serve for balancing the ELIA system at that moment or for cross-border exchanges of balancing energy, the concerned mFRR Energy Bids must be set to unavailable for activation via the mFRR-Platform.

### 7.5.3. Guaranteed Volume

The result of the mFRR-Platform may also be that too much mFRR Energy Bids in the ELIA LFC Block are activated as Scheduled Activation. Consequently, there may be too few or no mFRR Energy Bids available for Direct Activations for the same quarter-hour. In accordance with article 9 of the mFRR IF, to avoid being confronted with an insufficiency of required reserve capacity (also referred to as “**Guaranteed Volume**”), TSOs can ensure that a minimum volume remains available for Direct Activation.

Concretely, this implies that the TSO can set mFRR Energy Bids submitted for Scheduled Activation as well as Direct Activation to unavailable for Scheduled Activation. The mFRR Energy Bids as a result remain **available on the mFRR-Platform for Direct Activations only**.

The mFRR Energy Bids that a TSO can indicate as guaranteed volume, must have been offered by the BSP for both Scheduled Activation and Direct Activation, and are the bids that are at the end of the Local Merit Order. The selection of bids for guaranteed volume is similar to the local selection of bids for mFRR activation, but in reverse (i.e., starting from the end of the Merit Order List): given the rules of transmission of bids to the mFRR-Platform, once one bid that is part of a parent-child group or an exclusive group is selected for guaranteed volume, all associated bids are selected for guaranteed volume. The entire volume of the bids in the parent-child group is, therefore, considered as a guaranteed volume. In an exclusive group, the maximum bid volume of the group is considered as guaranteed volume. Per quarter-hour, a TSO can indicate a guaranteed volume that is maximum the volume of the dimensioned reserve capacity needs minus the TSO's demand for Scheduled Activation in the concerned direction for the concerned quarter-hour.

#### **7.5.4. Avoiding erroneous activation**

In case, after mFRR Balancing GCT, ELIA considers an mFRR Energy Bid as manifestly erroneous, ELIA has the right to put the mFRR Energy Bid as unavailable for activation.

## 8. Selection of mFRR Energy Bids for balancing purposes

**Before connecting to the mFRR-Platform**, ELIA selects and activates mFRR Energy Bids based on the local merit order and purely for own purposes or at the request of one of the neighboring TSOs in respect of the mFRR Sharing Agreements.

**Once ELIA has connected to the mFRR-Platform**, the mFRR-Platform selects Belgian mFRR Energy Bids for activation based on a European common merit order and a European optimization. As described in section 0 of this document, the activation of mFRR Energy Bids in Belgium will then not necessarily be due to the existence of an mFRR demand of ELIA. In the event of a disconnection from the mFRR-Platform (e.g., if the mFRR-Platform is not available because of a technical issue or if ELIA tools that communicate with the platform are down), ELIA will again activate mFRR Energy Bids using the previous local selection principles as a **fallback procedure**.

This section focuses on **selection for activation for balancing purposes**. Activations via the mFRR-Platform may be requested for other purposes as well, however, this does not affect the preprocessing of the bids by ELIA or the activation requirements vis-à-vis the BSP. Local activations by ELIA for other purposes than balancing will be discussed in section 13.

### 8.1. ELIA preprocessing of mFRR Energy Bids when connected to the mFRR-Platform

By 12 minutes before the start of the concerned quarter-hour, ELIA must transmit to the mFRR-Platform all the mFRR Energy Bids received from the BSPs for this quarter-hour. For each quarter-hour  $QH_0$ , ELIA performs the preprocessing by sending to the mFRR-Platform all the validated<sup>36</sup> mFRR Energy Bids submitted for this  $QH_0$  and considered as available by ELIA at the time of sending. If needed, after RT-12' and until RT+5', ELIA may send updated mFRR Energy Bids to the mFRR-Platform (because of bids update requested by the BSPs, as per section 7.4 or because of availability status modified by ELIA, as per section 7.5). However, the new information will only be taken into consideration by the AOF for optimizations that have not started yet.

Based on the mFRR Energy Bids transmitted by the Participating TSOs, the mFRR-Platform creates Common Merit Order Lists (i.e., the **CMOL**) for positive and negative energy. The CMOLs together with the TSOs' mFRR demands and the information on cross-border capacities as well as the activations of the previous quarter-hour(s) (cf. section 7.1.2.7.3) serve as input for the mFRR-Platform, which selects the mFRR Energy Bids to be activated for the concerned quarter-hour. For each LFC Block and quarter-hour, the mFRR-Platform sends the selected mFRR Energy Bids to the concerned TSO(s):

- ELIA receives the upward and/or the downward mFRR Energy Bids selected during the "Scheduled Activation optimization run" around RT-8' in order to send the activation requests to the BSPs at RT-7,5'.
- Afterwards ELIA may receive the upwards mFRR Energy Bids selected during the "positive Direct Activation optimization run" and/or the downwards mFRR Energy Bids selected during the "negative Direct Activation optimization run" at different times. ELIA sends the activation requests to the BSPs at the latest right before RT+7.5' (i.e., right before the Point of Scheduled Activation of the next quarter-hour).

---

<sup>36</sup> As per the BSP Contract mFRR, each time (the update of) an mFRR Energy Bid is submitted to ELIA, checks are performed by ELIA. In case of non-compliance with the requirements of these checks, the concerned mFRR Energy Bid is automatically rejected.

## 8.2. Fallback procedure

EBGL Article 28 – Fall-back procedures
--

3. Where the coordinated activation of balancing energy fails, each TSO may deviate from the common merit order list activation and shall inform market participants as soon as possible.
---

In accordance with the article 28 of the EBGL, when the coordinated activation via the mFRR-Platform is not available or when ELIA disconnects from the mFRR-Platform due to causes at the European or the Belgian side, ELIA will fall back to the procedure for local selection and activation of mFRR Energy Bids as described in section 8.3.

## 8.3. Local selection of mFRR Energy Bids for balancing purposes

ELIA plans to implement explicit bidding and requirements of new mFRR design (as explained in section 7.1) as of Q1 2024 (i.e., **before formally connecting to the mFRR-Platform**). During this “in-between” period, ELIA will locally select mFRR Energy Bids for activation based on the procedures described in the sections below. ELIA will also use this procedure in case of disconnection from the mFRR-Platform or unavailability of the platform (cf. section 8.2).

### 8.3.1. Preprocessing

Before creating the Local Merit Order Lists (i.e., the **LMOL**), ELIA prepares each mFRR Energy Bid of a quarter-hour  $QH_0$ , as follows:

- If requested on time (i.e., before ELIA starts the selection procedure, as per section 8.3.3), bid volume modification at the request of the BSP (as per section 7.4) are taken into account.
- If the mFRR Energy Bid is technically linked to another mFRR Energy Bid of the previous quarter-hour (i.e.,  $QH_{-1}$ ) and that this mFRR Energy Bid of  $QH_{-1}$  is activated, then ELIA sets the mFRR Energy Bid of  $QH_0$  to unavailable for local activation. This will also have an influence on other mFRR Energy Bids of  $QH_0$  in case all those bids are grouped in a parent-child or an exclusive group.
- If the mFRR Energy Bid is conditionally linked to another mFRR Energy Bid of the previous quarter-hour (i.e.,  $QH_{-1}$ ), then ELIA sets the mFRR Energy Bid of  $QH_0$  to available or unavailable for local activation depending on the status of this mFRR Energy Bid of  $QH_{-1}$  by following the rules of Table 7 and Table 8). This will also have an influence on other mFRR Energy Bids of  $QH_0$  in case all those bids are grouped in a parent-child or an exclusive group.
- If the mFRR Energy Bid has already been activated for an availability test (defined in section 11.1.2) or for redispatching (defined in section 13) then ELIA sets the mFRR Energy Bid to unavailable for local activation.

The result of the above steps is a collection of mFRR Energy Bids that are validated<sup>36</sup> and considered as available for activation for balancing purposes. Please note that only the mFRR Energy Bids considered as available by ELIA will be taken into account when creating the Local Merit Order List. Indeed, as per sections 7.5.1, 7.5.3 and 7.5.4, it is possible that ELIA sets an mFRR Energy Bid to unavailable for local activation.

### 8.3.2. Local Merit Order List creation

Based on the collection of available mFRR Energy Bids prepared as explained in the previous section, ELIA creates two merit order lists depending on direction:

- Positive LMOL: the Local Merit Order List for upwards mFRR Energy Bids, which ranks the mFRR Energy Bids from **lowest to highest bid price** (as depicted in Figure 23);
- Negative LMOL: the Local Merit Order List for downwards mFRR Energy Bids, which ranks the mFRR Energy Bids from **highest to lowest bid price** (as depicted in Figure 24).

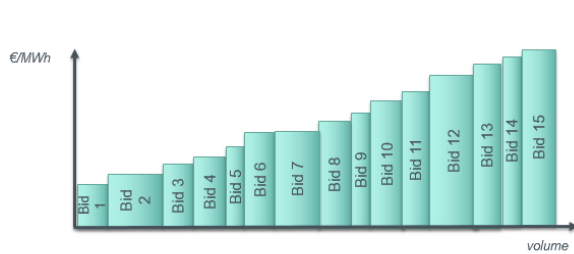

Figure 23. Positive energy merit order

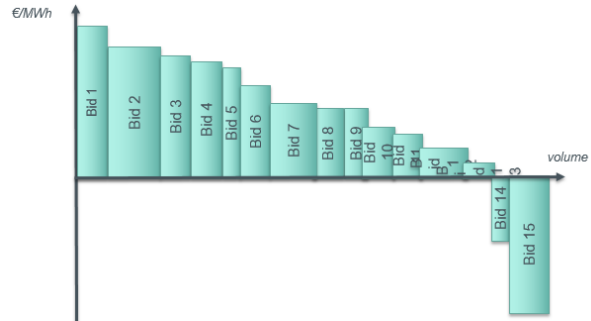

Figure 24. Negative energy merit order

### 8.3.3. Local selection of bids

When ELIA has an mFRR demand (or in case of a demand of a neighboring TSO in respect of a Reserve Sharing Agreement), ELIA will select mFRR Energy Bids to cover this demand by using the Local Merit Order Lists and applying the below rules for the marginal bid.

Once the Local Merit Order Lists are created, the remaining bid characteristics that are relevant for selection are the bid volume, the minimum volume (indication of indivisibility) and the association to an exclusive or a parent-child group. For each quarter-hour for which ELIA has an mFRR demand for Scheduled Activation and/or Direct Activation(s) ELIA performs the following two steps in sequence:

- In case of mFRR demand(s) for Scheduled Activation, ELIA performs an **optimisation for Scheduled Activation**: ELIA selects, according to a merit order activation mechanism based on the LMOLs, the mFRR Energy Bids that need to be activated (to cover the mFRR demand for SA) and the requested power per mFRR Energy Bid (i.e., mFRR Requested). The activation takes into account the properties of the mFRR Energy Bids, as defined in section 7.1.2.
- In case of mFRR demand(s) for Direct Activation, ELIA performs **one (or more) optimization(s) for Direct Activation**: the LMOLs are first updated to take into account the impact of the previous selection round<sup>37</sup>. Then, ELIA selects, according to a merit order activation mechanism based on the updated LMOLs, the mFRR Energy Bids that need to be activated (to cover the mFRR demand for DA) and the requested power per mFRR Energy Bid (i.e., mFRR Requested). The activation takes into account the properties of the mFRR Energy Bids, as defined in section 7.1.2.

There are three cases where the characteristics of the marginal bid in the initial selection affect the final selection:

- Case 1: The marginal bid is a fully divisible bid that is not part of an exclusive group. The, the marginal bid is selected partially or fully.

<sup>37</sup> Concretely this implies that each mFRR Energy Bid that was activated in SA or part of an exclusive group in which another bid was activated in SA, is set at unavailable and therefore excluded from the new Local Merit Order Lists for the subsequent Direct Activations.



- Case 2: The volume needed from the marginal bid is smaller than the bid's minimum volume (i.e., the bid is partially indivisible). Then if the volume needed by ELIA from the marginal bid is smaller than the bid's minimum volume, ELIA will not select the marginal bid for activation.
- Case 3: The initial selection of bids contains more than one bids part of the same exclusive group. The, ELIA selects the mFRR Energy Bid of the exclusive group that has the largest bid volume. This selection process is done only once per exclusive group.

The result of the local selection procedure is a list of mFRR Energy Bids that are:

- selected for activation: The volume of all of these bids is fully activated except potentially the marginal bid, which may be partially or fully activated; or
- unforeseeably rejected: These are the bids that are not selected for activation despite having a bid price that is lower (respectively higher) than the Marginal Price in case of upward (respectively downward) activation. This can only be the case for bids that are part of an exclusive group; or
- rejected: These are the bids that have a bid price higher (respectively lower) than the Marginal Price.

## 9. Activation of mFRR Energy Bids

Regardless of the fact that the selection may be done locally by the mFRR-Platform, the result is a list of mFRR Energy Bids for which ELIA has to request an activation to the BSP. The activation request of an mFRR Energy Bid comprises the following information:

- The start and end time of the activation;
- The type of activation (Scheduled Activation or Direct Activation);
- The mFRR Requested (with a granularity of 1 MW).

ELIA sends the activation request for each bid to the concerned BSP by electronic message.

### 9.1. mFRR requested

For each selected mFRR Energy Bid, the activation request includes the volume that the BSP has to activate; being the **“mFRR Requested” (in MW)**. The BSP has to obtain this power value by the end of the Full Activation Time (equal to 12.5 minutes). As described in section 2.2, depending on the type of activation requested, the BSP has to follow the activation profile of the Scheduled Activation or of the Direct Activation. As per section 11.2, ELIA will consider the profiles of the requested activation type to determine the energy that is to be supplied.

### 9.2. BSP response

Important information no longer valid in the next design: The BSP may, if justified, reject the activation of a non-contracted mFRR Energy Bid on DP<sub>SU</sub>.

After receiving the activation request, the BSP must respond by sending ELIA two acknowledgement messages:

- **Acceptation (1<sup>st</sup> acknowledgement message from the BSP):**

At the latest 5 minutes after the activation request has been received by the BSP, the latter communicates to ELIA an acknowledgement message including the list of the **Delivery Points that the BSP intends to use** to deliver the energy requested for each quarter-hour concerned by the activation request, as well as the expected contribution of each Delivery Point to this delivery. The list of Delivery Points in the acceptance message is limited by the rules defined in section 9.3. The BSP makes its best efforts to provide accurate data in this notification.

- **Confirmation (2<sup>nd</sup> acknowledgement message from the BSP):**

At the latest 8 minutes after the end of the last quarter-hour of the activation, the BSP communicates to ELIA the **final list of Delivery Points<sup>38</sup> used** to deliver the energy requested for each quarter-hour concerned by the activation, as well as the contribution of each Delivery Point to this delivery. This list of Delivery Points is used for the activation control, as per section 11.2, and for an availability test, as per section 11.1. In case the BSP indicates an activated volume of 0 MW for a Delivery Point, it will not be further taken into account in the activation control.

The BSP may not reject any requested activation.

---

<sup>38</sup> The Delivery Points included in the 2<sup>nd</sup> acknowledgment message must have been part of the 1<sup>st</sup> acknowledgment message.

the above-mentioned timings (through no fault of ELIA), the activation is considered as failed and penalties shall apply, in accordance with section 12.

Under the circumstances that ELIA receives only one acknowledgement message, the information provided in this message will be considered for activation control, in accordance with section 11.2, and for availability test, in accordance with section 11.1.

In case of a forced outage after the start of the activation, the BSP must notify ELIA without delay. The rules on settlement remain applicable.

### 9.3. Use of DP in response to an activation request

Important information no longer valid in the next design: The BSP must always use the Delivery Points listed in the selected mFRR Energy Bid to respond to an activation.

An activation request is sent at the level of the mFRR Energy Bid. As described in section 7.1.2.9, mFRR Energy Bids may include different Delivery Points. As per section 9.2, in response to an activation request, the BSP has to confirm in the acknowledgement messages sent to ELIA which Delivery Points will be (BU ACK 1) and were (BU ACK 2) used.

If needed, the BSP may perform the activation on other Delivery Points than those included in the mFRR Energy Bid. Indeed, to perform the activation of an mFRR Energy Bid submitted for quarter-hour  $Qh_0$ , the BSP may choose among the Delivery Points included in the mFRR Energy Bids and/or in the Supporting mFRR Providing Group submitted by the BSP for this same quarter-hour<sup>39</sup>. The use of alternative Delivery Points does not exempt the BSP from providing the volume that was offered in the bid(s) in which this alternative Delivery Point was included (if this bid would also be activated). The permission to use Delivery Points that are included in other bids therefore implies a real-time facilitation for the BSP, but it does not exonerate the BSP from delivering the volume from the bid selected for activation.

For each quarter-hour concerned by the activation<sup>40</sup>, four exceptions for which a Delivery Point cannot be used (and will therefore not be considered by ELIA for the activation control) for an upward (respectively downward) activation exist, being (as illustrated in some examples on Figure 25, Figure 26, Figure 27 and Figure 28):

- The Delivery Point is included in an Electrical Zone with a Medium Level of CRI in the upward (respectively downward) direction or a High Level of CRI in the upward (respectively downward) direction for the concerned quarter-hour, and all upward (respectively downward) mFRR Energy Bids submitted for quarter-hour  $Qh_0$  related to the Delivery Point, are put at unavailable for activation because of a CRI filtering (cf. section 7.5.1) or because of an error identified by ELIA (cf. section 7.5.4).
- On the condition that the Delivery Point is not part of any upward (respectively downward) mFRR Energy Bids submitted for quarter-hour  $Qh_0$ , the Delivery Point is, included in an Electrical Zone with a an incremental (respectively decremental) Medium Level of CRI or a High Level of CRI for the concerned quarter-hour, and listed in the Supporting mFRR Providing Group submitted for quarter-hour  $Qh_0$ .
- The 2<sup>nd</sup> acknowledgement message includes other Delivery Points than those included in the 1<sup>st</sup> acknowledgement message.
- The Delivery Point has been included in 2<sup>nd</sup> acknowledgement message includes with a contribution (“cb” in the figure below) of 0 (zero) MW.

<sup>39</sup> This rule does not apply in case ELIA activates the mFRR Energy Bid in the framework of an availability test or to solve a congestion issue. Indeed, in those situations, the BSP can only use the Delivery Points included in the activated mFRR Energy Bid.

<sup>40</sup> In case of Scheduled Activation, only one quarter-hour is concerned:  $Qh_0$ . In case of Direct Activation, two quarter-hours are concerned:  $Qh_0$  and  $Qh_{+1}$ .

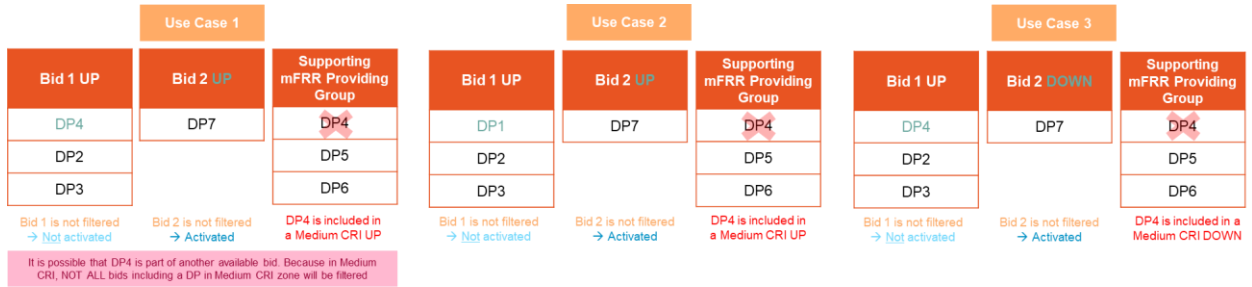

	Is this allowed to use the following DPs to deliver the power for "Bid 2"?						
	DP1	DP2	DP3	DP4	DP5	DP6	DP7
Use Case 1	N/A	Allowed	Allowed	Allowed	Allowed	Allowed	Allowed
Use Case 2	Allowed	Allowed	Allowed	Not allowed	Allowed	Allowed	Allowed
Use Case 3	N/A	Allowed	Allowed	Not allowed	Allowed	Allowed	Allowed

Figure 25. Illustration 1 of cases where a Delivery Point cannot be used to deliver the mFRR Power for an activation

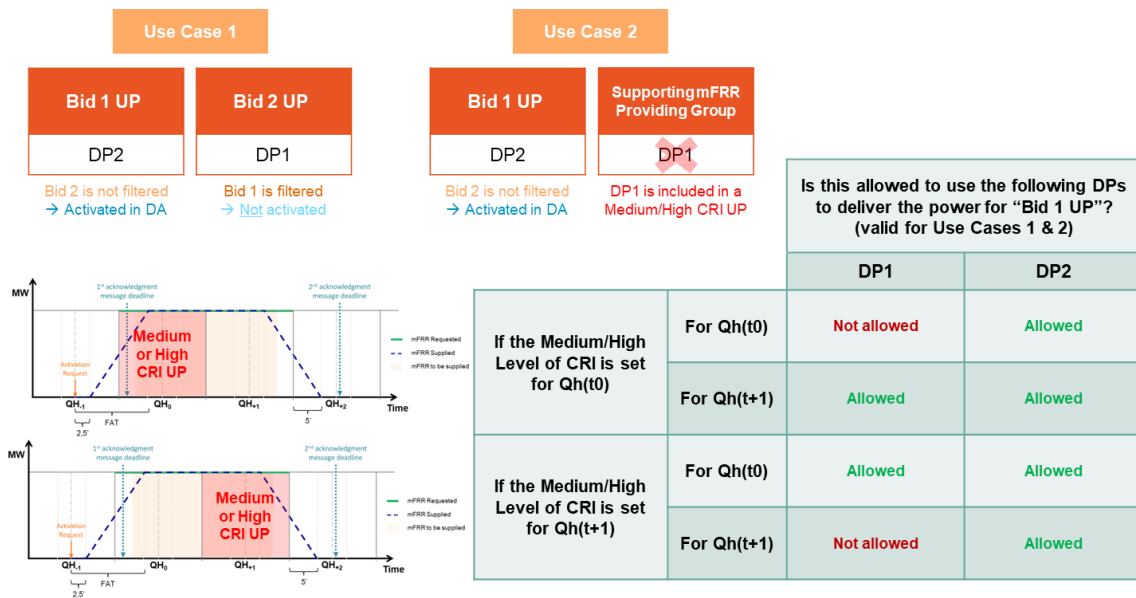

Figure 26. Illustration 2 of cases where a Delivery Point cannot be used to deliver the mFRR Power for an activation

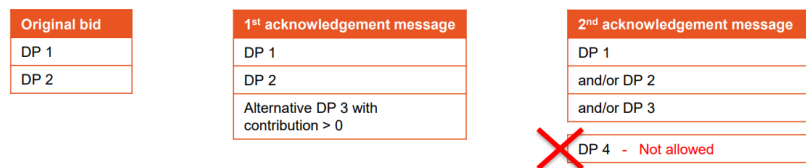

Figure 27. Illustration 3 of cases where a Delivery Point cannot be used to deliver the mFRR Power for an activation

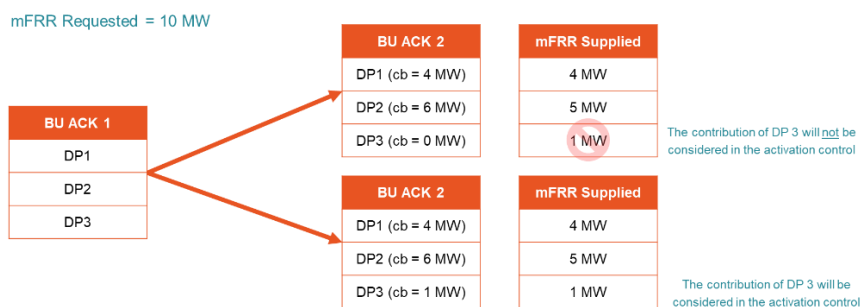

Figure 28. Illustration 4 of cases where a Delivery Point cannot be used to deliver the mFRR Power for an activation

ELIA takes the activation of alternative Delivery Points into consideration in the mFRR activation control (see section 11.2). ELIA does not take the use of alternative Delivery Points into consideration for the mFRR Energy remuneration or for the preprocessing for subsequent selections of mFRR Energy Bids in the same or consecutive quarter-hour.

## 9.4. Multiple activations on a Delivery Point part of a same Providing Group

A Delivery Point part of a same mFRR Providing Group may be subject to multiple activations in the same quarter-hour or in consecutive quarter-hours. This section highlights some attention points regarding that possibility.

### 9.4.1. Multiple activations during the same quarter-hour

A BSP may submit several mFRR Energy Bids in the same mFRR Providing Group. For example, if the BSP wants to offer a volume:

- in one direction but with different bid characteristics (e.g., different bid prices); or
- in the two directions (e.g., a change of active power in both directions is available on the same Delivery Point).

Per quarter-hour, the mFRR-Platform performs one optimization for the Scheduled Activations and potentially one (or more) optimization(s) for the Direct Activations.

If both positive and negative volumes are offered on the same providing group during the same quarter-hour, mFRR Energy Bids may be selected:

- for SA in both directions due to the counter activations, there might be activations in the two directions requested as output of the AOF (on the contrary of PICASSO where bids can be activated in only one direction at the end of each AOF);
- for SA in one direction & for DA in the other direction because SA optimization run will optimize the two directions at the same time while each DA optimization run will run in one direction;
- for DA in both directions because two (or more) DA optimizations occurred in the two directions. Therefore, there may be several DA in different directions during the same quarter-hour.

Consequently, depending on which Delivery Point are included in the mFRR Energy Bids and in the Supporting mFRR Providing Group submitted for a quarter-hour, and depending on the positions of the concerned submitted mFRR Energy Bids in the merit orders, a same Delivery Point could be used to perform (multiple) Scheduled Activation(s) and/or (multiple) Direct Activation(s) on the same quarter-hour.

**If a Delivery Point is included in both positive and negative mFRR Energy Bids selected** for the same quarter-hour, then the BSP must deliver the net result of the mFRR Power that is requested.

If the net result of the requested activations in positive and negative direction on the same mFRR Providing Group is not technically feasible (e.g., due to rules on indivisible volume), then the BSP can avoid the combined activation by putting the positive and the negative bids in a common exclusive group. Example is depicted in Figure 29.

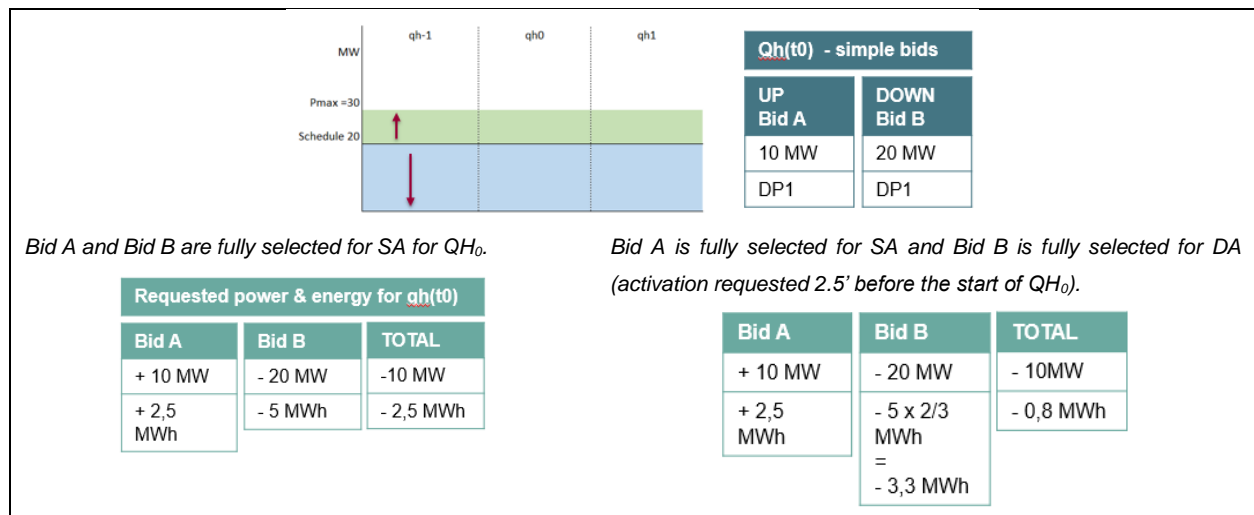

Figure 29. Example of positive and negative activation in the same quarter-hour

If multiple bids in the same direction are selected for (Scheduled or Direct) Activation for the same quarter-hour, then the BSP must deliver the total result of the mFRR Power that is requested. A priori this should not be a problem as the BSP submitted the volume split in several bids. Note, however, that in case of a combination of a Scheduled Activation and one (or more) Direct Activation(s), the total power to be delivered would change from the first quarter-hour to the second. Note also that on the mFRR-Platform, the remaining volume of a (fully or partially divisible) mFRR Energy Bid that is partially activated in Scheduled Activation, will no longer be considered as available in optimizations for Direct Activation for the same quarter-hour. Other mFRR Energy Bids with additional volume offered on the same Providing Group may, however, still be available for Direct Activation. This is illustrated in Figure 30.

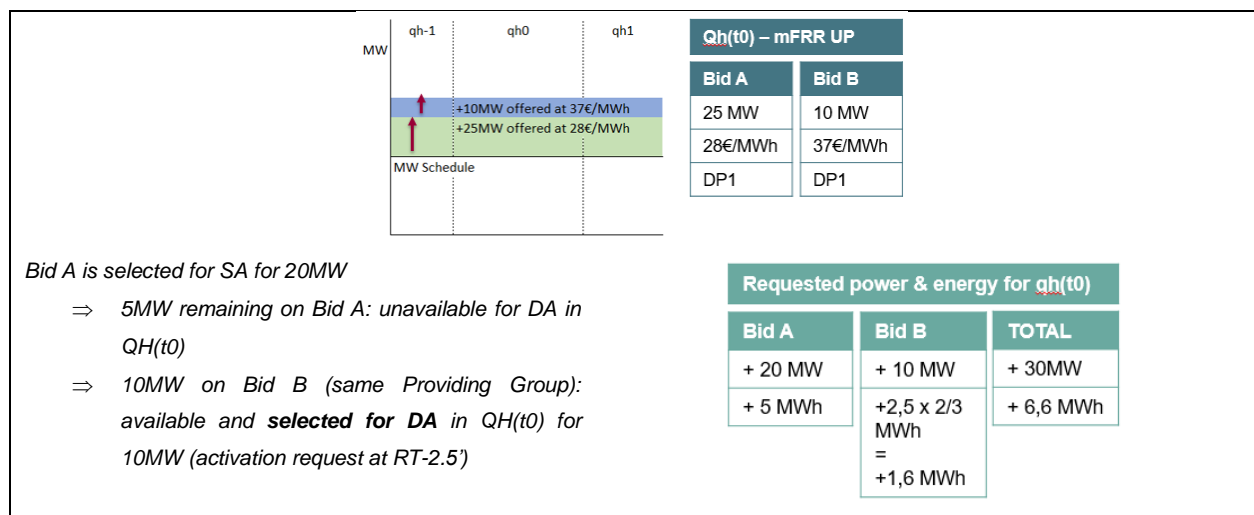

Figure 30. Example of multiple positive activations in the same quarter-hour

### 9.4.2. Multiple activations during consecutive quarter-hours

The following consecutive activations may occur on available mFRR Energy Bids:

	QH(t0)	QH(t+1)	QH(t+2)	QH(t+3)	...
<b>SA followed by SA:</b>	SA	SA	...	...	...
<b>SA followed by DA:</b>	SA	DA started	[DA from QH(t+1) still ongoing]	...	...
<b>DA followed by SA:</b>	DA started	[DA from QH(t0) still ongoing]	SA	...	...
<b>DA followed by DA:</b>	DA started	[DA from QH(t0) still ongoing]	DA started	[DA from QH(t+2) still ongoing]	...

Table 10. Possible Consecutive Scheduled Activations (SA) and/or Direct Activations (DA)

The **consecutive activations** depicted in Table 10 can be for activation in the **same or in the opposite direction**.

As depicted on the left side of Figure 31 and Figure 32, the request for SA for QH(t0) is always sent at RT-7,5' for QH(t0) while the deactivation of an activation in the previous quarter-hour starts at T+10' for QH(t-1) or in other words RT-5' for QH(t0). Therefore, the BSP is aware of a new SA before starting the deactivation period of a previous activation and can thereby avoid ramping in the upward or in the downward direction between the two activations.

As depicted on the right side of Figure 31 and Figure 32, a request for DA for QH(t0) can, however, occur when deactivation of delivery in the previous quarter-hour has already started.

As depicted Figure 32, in case of consecutive activations in opposite direction, the ramping between the two requested powers would have to be performed twice as fast as in case of a 'first-time' activation.

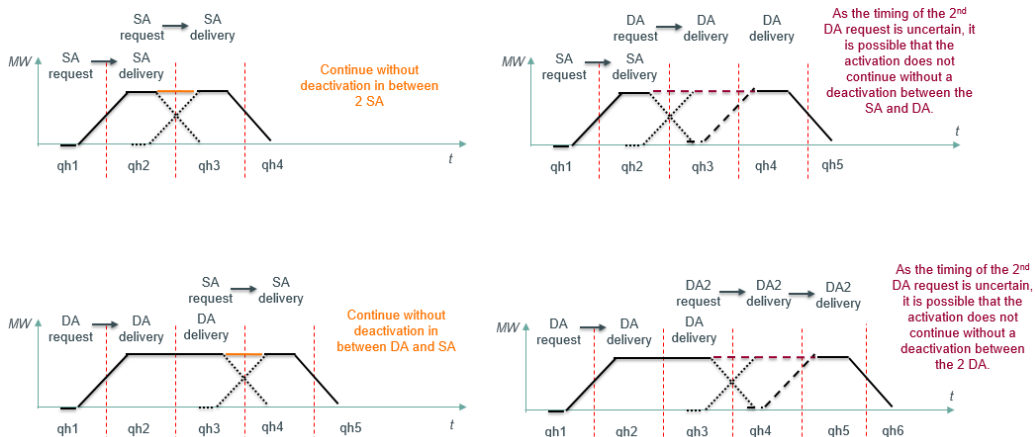

Figure 31. Consecutive activations on the same mFRR Providing Group in the same direction

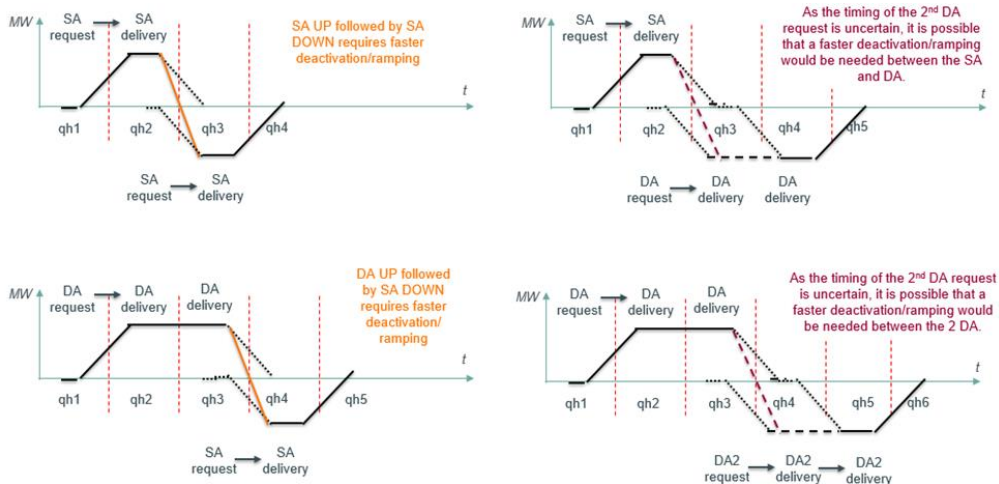

Figure 32. Consecutive activations on the same mFRR Providing Group in the opposite direction

## 10. Remuneration

### 10.1. Remuneration of mFRR Awarded

There is at this stage no change foreseen in the remuneration of mFRR Capacity (currently paid-as-bid). As presented in the Working Group Balancing (in the framework of the incentive study performed in 2020 and the discussions regarding the balancing roadmap 2021-2022), the possible change to a paid-as-cleared remuneration is subject to a follow-up analysis after the connection to the EU mFRR-Platform.

The mFRR capacity auctions result in an mFRR Awarded for the concerned BSPs. The awarded mFRR Capacity is remunerated according to the paid-as-bid mechanism: ELIA pays the BSP the price requested in each selected mFRR Capacity Bid.

The remuneration for one mFRR Capacity Bid is equal to the multiplication of:

- the price, in €/MW/h, of the awarded mFRR Capacity Bid; and
- the number of MW awarded of said mFRR Capacity Bid; and
- the number of hours of the CCTU concerned.

### 10.2. Remuneration of mFRR Requested

Important information no longer valid in the next design:

- The clearing price for mFRR Energy is determined nationally and may be different for non-contracted mFRR and mFRR Standard Energy Bids than for mFRR Flex Energy Bids.
- There is a separate settlement of start-up costs which will no longer be possible in the future.

#### EBGL

##### Article 45 – Balancing energy calculation

1. As regards the settlement of balancing energy for at least the frequency restoration process and the reserve replacement process, each TSO shall establish a procedure for: (a) the calculation of the activated volume of balancing energy based on requested or metered activation; (b) claiming the recalculation of the activated volume of balancing energy.

2. Each TSO shall calculate the activated volume of balancing energy according to the procedures pursuant to paragraph 1(a) at least for: (a) each imbalance settlement period; (b) its imbalance areas; (c) each direction, with a negative sign indicating relative withdrawal by the BSP, and a positive sign indicating relative injection by the BSP.

3. Each connecting TSO shall settle all activated volumes of balancing energy calculated pursuant to paragraph 2, with the concerned BSPs.

##### Article 47 – Balancing energy for frequency restoration process

1. Each connecting TSO shall calculate and settle the activated volume of balancing energy for the frequency restoration process with BSPs pursuant to paragraphs 1 and 2 of Article 45.

2. The price, be it positive, zero or negative, of the activated volume of balancing energy for the frequency restoration process shall be defined for each direction pursuant to Article 30 as defined in the Table 1.



Table 1		
Payment for balancing energy		
	Balancing energy price positive	Balancing energy price negative
Positive balancing energy	Payment from TSO to BSP	Payment from BSP to TSO
Negative balancing energy	Payment from BSP to TSO	Payment from TSO to BSP

**Methodology for pricing balancing energy**

Article 2 – Definitions and interpretation  
**‘accepted bid volume’** means the balancing energy volume from a balancing energy product bid to be settled in accordance with national terms and conditions related to balancing pursuant to Article 18(5)(h) of the EB Regulation, which requires the development of the rules for the determination of the volume of balancing energy to be settled with the BSP pursuant to Article 45 of the EB Regulation;

Article 3 – General principles

- The CBMP shall be calculated by the activation optimisation functions as follows:
  - the AOF of the mFRR-Platform shall calculate one CBMP for standard mFRR balancing energy product bids with Scheduled Activation type selected for the balancing purpose for both activation directions, for each market time unit for standard mFRR balancing energy product bids (hereafter referred to as “mFRR MTU”) and for each uncongested area;
  - the AOF of the mFRR-Platform shall calculate one CBMP for standard mFRR balancing energy product bids with Direct Activation type selected for the balancing purpose for each activation direction, for each mFRR MTU, and for each uncongested area;
- Each TSO shall determine the accepted bid volume of each selected bid for each MTU

As long as ELIA locally selects mFRR Energy Bids for activation, the clearing prices are determined locally. Once connected to the mFRR-Platform, the clearing prices for the mFRR Energy Bids activated in the ELIA LFC Block will be determined on a European level.

Regardless of local or European clearing prices, the payment of the energy remuneration follows the guidelines of the table 1 in the EBGL (cf. box above).

Each activated mFRR Energy Bids is remunerated Each separately based on the **applicable price** (as per section 10.2.1) and the **mFRR energy requested (in MWh)** for the concerned quarter-hour (as per section 10.2.2):

$$Remuneration_{bid} = mFRR\ energy\ requested_{bid} * applicable\ price_{bid}$$

The mFRR energy requested is the energy corresponding to the mFRR Requested (in MW) for the concerned quarter-hour, taking into consideration the start time of the activation request.

### 10.2.1. Applicable price

mFRR energy remuneration is based on the **“pay-as-clear”** principle: All mFRR Energy Bids in the same selection are remunerated at the same **Marginal Price (MP)**. The Marginal Price determination is based on the “Methodology for pricing balancing energy and cross-zonal capacity used for the exchange of balancing energy or operating the imbalance netting process” established in accordance with the article 230(1) of the EBGL.

In case of local selection, the Marginal Price s are determined based on ELIA’s selection in the Merit Order List (i.e., the “LMOL”) and are called the **“Local Marginal Prices” (LMP)**. When connected to the mFRR-Platform, the Marginal

Prices are determined by the mFRR-Platform per uncongested area and are called the “**Cross-Border Marginal Prices**” (CBMP).

For one quarter-hour, there can be **up to five Marginal Prices** (see Figure 33), depending on the type of activation (SA or DA) that was requested for the concerned quarter-hour and for the previous one.

	QH <sub>-1</sub>	QH <sub>0</sub>	QH <sub>1</sub>
SA requested for QH <sub>-1</sub>	$MP_{SA,QH_{-1}}$		
Positive DA requested for QH <sub>-1</sub>	$MP_{DA,up,QH_{-1}}$		
Negative DA requested for QH <sub>-1</sub>	$MP_{DA,down,QH_{-1}}$		
SA requested for QH <sub>1</sub>		$MP_{SA,QH_0}$	
Positive DA requested for QH <sub>0</sub>		$MP_{DA,up,QH_0}$	
Negative DA requested for QH <sub>0</sub>		$MP_{DA,down,QH_0}$	

Figure 33. Overview of mFRR Energy delivery and clearing prices for QH(t0)

Per quarter-hour, there is always only one MP (i.e., the LMP or the CBMP) used for the mFRR Energy Bids selected for a Scheduled Activation (both in the positive and negative direction). However, per quarter-hour, there are possibly four MP (i.e., the LMP or the CBMP) used for the mFRR Energy Bids selected for a Direct Activation:

- One for the activations requested for the concerned quarter-hour and going in the positive direction;
- One for the activations requested for the concerned quarter-hour and going in the negative direction;
- One for the activations requested for the previous quarter-hour and going in the positive direction;
- One for the activations requested for the previous quarter-hour and going in the negative direction.

However, there are only one applicable price for an mFRR Energy Bid. Each activation will be remunerated separately even if there are multiple activations (in the same or in different directions) during the same quarter-hour. mFRR Energy Bids that are not selected for activation because of the status “unavailable” are not remunerated.

The price applicable for each mFRR Energy Bid is determined as follows:

### Applicable price for a Scheduled Activation

There is only one Point of Scheduled Activation for a quarter-hour QH, which results in a list of mFRR Energy Bids to activate (possibly both in positive and negative directions when connected to the mFRR-Platform), and in **one Marginal Price** (“ $MP_{SA,QH}$ ”) that satisfies the conditions of all selected bids. This Marginal Price is applicable for the determination of the remuneration of all mFRR Energy Bids selected for Scheduled Activation with a delivery in the QH:

$$applicable\ price_{bid} = MP_{SA,QH}$$

### Applicable price for a Direct Activation in the positive (resp. negative) direction

There can be multiple moments of Direct Activations in the positive (resp. negative) direction during a quarter-hour QH. The result is a list of mFRR Energy Bids to activate. All Direct Activations require delivery in the concerned quarter-hour QH as well as in the next quarter-hour QH<sub>+1</sub>. Of these selected bids, the one with the highest (resp. lowest) price sets the Marginal Price for all the bids selected for Direct Activation in positive (resp. negative) direction (“ $MP_{DA,up,QH}$ ”). The energy delivered for Direct Activation is, however, remunerated differently depending on the quarter-hour of delivery and depending on the difference with the Marginal Price for Scheduled Activation. Consequently, the energy

delivered in the first quarter-hour QH of a Direct Activation may be remunerated differently from the energy delivered in the second quarter-hour QH<sub>+1</sub>.

Therefore, the applicable price for an mFRR Energy Bid of quarter-hour QH is equal to the following:

- when ELIA requested a Direct Activation in the upward direction:
  - For the first quarter-hour of activation (QH):
 
$$\text{applicable price}_{bid} = \max(MP_{SA,QH}; MP_{DA,up,QH})$$
  - For the second quarter-hour of activation (QH<sub>+1</sub>):
 
$$\text{applicable price}_{bid} = \max(MP_{SA,QH+1}; MP_{DA,up,QH})$$
- when ELIA requested a Direct Activation in the downward direction:
  - For the first quarter-hour of activation (QH):
 
$$\text{applicable price}_{bid} = \min(MP_{SA,QH}; MP_{DA,down,QH})$$
  - For the second quarter-hour of activation (QH<sub>+1</sub>):
 
$$\text{applicable price}_{bid} = \min(MP_{SA,QH+1}; MP_{DA,down,QH})$$

### 10.2.2. mFRR energy requested

The mFRR energy requested of an mFRR Energy Bid is determined as follows:

- For a **Scheduled Activation** (i.e., the activation request is received **at the point of Scheduled Activation**), then the mFRR energy requested is fully remunerated fully (as depicted in green in Figure 34):

$$mFRR \text{ energy requested} = \frac{1}{4} \times mFRR \text{ Requested}$$

- For a **Direct Activation**:
  - o For the first quarter-hour of the activation (i.e., the activation request is received **after the point of Scheduled Activation**), then the mFRR energy requested is reduced in proportion to the delay of the activation request vis-à-vis the point of Scheduled Activation (as depicted in red in Figure 35).

$$mFRR \text{ energy requested} = \frac{1}{4} \times mFRR \text{ Requested} \times \frac{15 - \Delta t}{15}$$

Where  $\Delta t$  is the duration in minutes between the Direct Activation request and the Point of Scheduled Activation for the concerned quarter-hour.

- o For the second quarter-hour of the activation (i.e., the activation request is received **before of Scheduled Activation**), then the mFRR energy requested is fully remunerated fully (as depicted in green in Figure 35):

$$mFRR \text{ energy requested} = \frac{1}{4} \times mFRR \text{ Requested}$$

**Examples:**

- **Case 1: Scheduled Activation**

The activation request is sent 7.5 minutes before the start of the quarter-hour for which the concerned mFRR Energy Bid was submitted (cf. Figure 34).

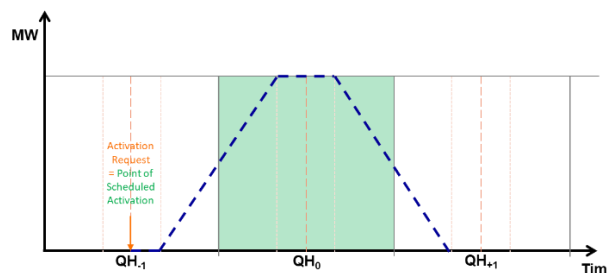

Figure 34. Remunerated energy for QH<sub>0</sub> in case of SA

Quarter-hour	mFRR Requested [MW]	mFRR energy requested [MWh]
QH <sub>-1</sub>	0	0
QH <sub>0</sub>	100	$100 \times \frac{1}{4} = 25$
QH <sub>+1</sub>	0	0

Table 11: Example of mFRR energy requested determination for a SA

• **Case 2: Direct Activation**

The activation request is sent 3 minutes after the Point of Scheduled Activation for which the concerned mFRR Energy Bid was submitted (cf. Figure 35).

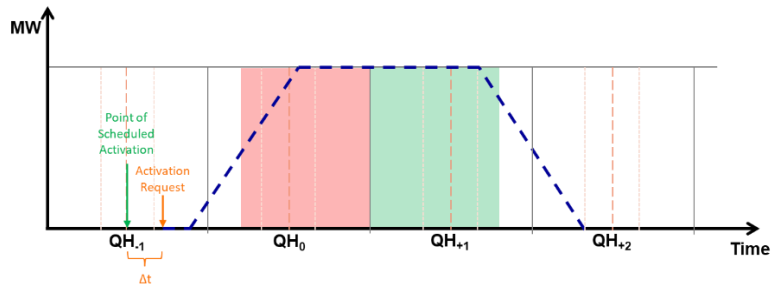

Figure 35. Remunerated energy for QH<sub>0</sub> and QH<sub>+1</sub> in case of DA

In such a case, Δt, being the duration in minutes between the Direct Activation request and the Point of Scheduled Activation for the concerned quarter-hour, is equal to 3 minutes.

Quarter-hour	mFRR Requested [MW]	mFRR energy requested [MWh]
QH <sub>-1</sub>	0	0
QH <sub>0</sub>	100	$100 \times \frac{15 - 3}{15} \times \frac{1}{4} = 20$
QH <sub>+1</sub>	100	$100 \times \frac{1}{4} = 25$
QH <sub>+2</sub>	0	0

Table 12: Example of mFRR energy requested determination for a DA

## 11. Controls

### 11.1. Availability controls

#### 11.1.1. Control of the mFRR Made Available

The control of the mFRR Made Available has been updated due to the introduction of the new explicit bidding and the new bid characteristics (as described in section 7.1.2).

BSPs are obliged to submit mFRR Energy Bids in respect of their mFRR Obligation (either due to the mFRR Balancing Capacity the BSP sold to ELIA in the day-ahead capacity auction or due to a Transfer of Obligation from another BSP). ELIA verifies therefore for each quarter-hour whether the mFRR Energy Bids submitted provide ELIA at least the volume of the concerned mFRR Obligation.

To determine whether the BSP for a specific quarter-hour complies with its mFRR Obligations, ELIA verifies whether the following sum is at least equal to the mFRR Obligation of the BSP:

- The volume of all contracted mFRR Energy Bids, being neither conditionally linked to another mFRR Energy Bid, nor included in an exclusive group (see section 7.1.2.7.2); and
- The volume of all contracted mFRR Energy Bids being conditionally linked to another mFRR Energy Bid and considered as available for activation at this time (i.e., the volumes that are either available or that have conditional link type of Table 7); and
- For each exclusive group, the largest offered volume amongst all the contracted mFRR Energy Bids included in the exclusive group.

When this above-mentioned sum is not equal to the corresponding mFRR Obligation for the concerned quarter-hour, the following rules applies:

- If the volume is lower than the mFRR Obligation, mFRR Made Available is set to this volume;
- If the volume is higher than (or equal to) the mFRR Obligation, mFRR Made Available is set to the mFRR Obligation.

If ELIA observes, during the control, that the mFRR Made Available is lower than the mFRR Obligation for a quarter-hour, ELIA applies penalties in accordance with section 12.1.

ELIA performs this control 7.5 minutes before the start of the concerned quarter-hour.

ELIA only exempts from this penalty the unavailability of volumes on contracted mFRR Energy Bids that were confronted with a forced outage, for the duration of the reconstitution time of 4 hours.

ELIA will not penalize the BSP for an mFRR Energy Bid that is unavailable because it includes one (or more) Delivery Point(s) located in (an) Electrical Zones with congestion risks (as defined in section 7.5.1). Nonetheless, as mentioned in section 7.5.1 on CRI filtering, ELIA expects the BSP to make its best effort to update the concerned mFRR Energy Bids so that the volume that is not located in a congested areas is liberated and therefore available for an mFRR activation. In case of insufficient bid updates, ELIA will address the concerned BSP. In case of excessive unavailability of mFRR volume due to a lack of efforts at BSP side, ELIA may in the future add incentives for bid update in the penalty on “mFRR Made Available”.

### 11.1.2. Availability test

The organization of availability tests remains as in the current design<sup>41</sup>.

Several times a year, ELIA verifies whether the mFRR energy that is offered in respect of an mFRR Obligation (either due to the mFRR Balancing Capacity the BSP sold to ELIA in the day-ahead capacity auction or due to a Transfer of Obligation from another BSP) is truly available. For this purpose, ELIA launches availability tests.

An availability test concerns an unannounced activation of one or more mFRR Energy Bid(s) of a BSP, thereby not in respect of the merit order.

ELIA sets the concerned mFRR Energy Bid(s) to unavailable for activation via the mFRR-Platform.

ELIA has the right to subject the full mFRR Obligation to an availability test at least once per year.

ELIA will perform at least one availability test per BSP per year. ELIA may perform up to 12 availability tests per period of 12 months (reduced to 6 tests in case of two successful successive availability tests) and demand that all DPs in a BSP's pool are included at least once in a test.

In response to the activation for an availability test, the BSP may only use the Delivery Points that have been included in the submitted mFRR Energy Bid(s).

The activation for the purpose of an availability test is not remunerated.

For an availability test, ELIA activates an mFRR Energy Bid for two consecutive quarter-hours. The bid should follow the profile that would have been followed if the bid was activated in DA with an activation request sent exactly at the Point of Scheduled Activation (or the profile that would have been followed by two exact same bids activated twice in a row in SA):

- The activation requested for the quarter-hour  $QH_0$  is sent 7.5 minutes before the start of the concerned  $QH_0$ ;
- After receiving the request, the BSP disposes of 12.5 minutes (FAT) to reach the mFRR Requested;
- After the FAT, the BSP delivers the mFRR Requested until 5 minutes before the end of the quarter-hour  $QH_{+1}$ ;
- The ramping down to the Baseline starts 5 minutes before the end of the quarter-hour  $QH_{+1}$ .

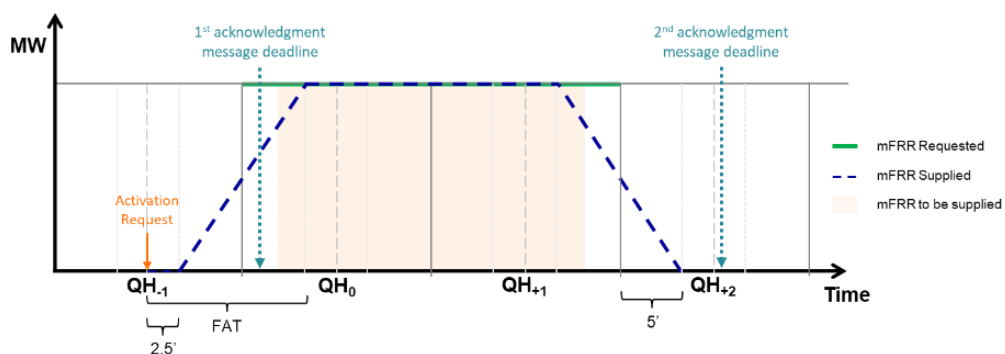

Figure 36: Availability test pattern

ELIA considers an availability test as failed if at least one of the following conditions is met:

- mFRR Missing MW is greater than 0 (zero), meaning that procured capacity appeared to not be available for activation;

<sup>41</sup> A review of the organization principles is also part of the study on the methodology on smart testing (see [https://www.ELIA.be/-/media/project/ELIA/ELIA-site/public-consultations/2020/20200915\\_smart-testing-ELIA-report-20201218\\_clean.pdf](https://www.ELIA.be/-/media/project/ELIA/ELIA-site/public-consultations/2020/20200915_smart-testing-ELIA-report-20201218_clean.pdf)) and foreseen for implementation at a later stage after the connection to the mFRR Platform.

- The BSP has failed to execute the communications foreseen in section 9.2 (through no fault by ELIA).

The mFRR Missing MW of an availability test is equal to the maximum between the mFRR Missing MW of the two quarter-hours concerned by the availability test:

$$mFRR \text{ Missing MW (availability test)} = \max[mFRR \text{ Missing MW } (QH_0); mFRR \text{ Missing MW } (QH_{+1})]$$

For each quarter-hour, the mFRR Missing MW is equal to the following:

$$mFRR \text{ Missing MW } (QH) = \left( 90\% \times \sum_{i=1}^{mFRR \text{ Energy Bids activated for the availability test}} mFRR \text{ Requested}_i \right) - mFRR \text{ Supplied}(QH)$$

The mFRR Supplied of the BSP at the level of the Delivery Points included in the mFRR Energy Bid(s) and used by the BSP to deliver the mFRR Requested for each quarter-hour of the availability test, is equal the total power supplied by the BSP during the quarter-hour QH at the level of the Delivery Points participating in the availability test.

The Missing MW are subject to a penalty as described in section 12.2.

In case of two failed consecutive availability tests, ELIA reduces the volume the concerned BSP may offer in a capacity auction ( $mFRR_{max}$ ) with the minimum value of the missing MW of the two tests.

## 11.2. Activation control

Attention point in comparison to current design:

- The activation control must be updated compared to the current design to take into consideration the new activation types and profiles.
- The activation control per activated bid is replaced by an activation control on the all the bids activated for a quarter-hour.

ELIA verifies for each quarter-hour whether the BSPs deliver the mFRR energy as requested. This activation control is important to monitor the quality of the mFRR Service. BSPs that do not manage to deliver mFRR as requested are subject to penalties as discussed in section 12.3.

### 11.2.1. Activation control of mFRR Energy bid

#### Determination of the mFRR energy to be supplied

Each activation of an mFRR Energy Bid for a value of “mFRR Requested” (in MW) implies expectations on “mFRR Energy to be supplied” (in MWh) for one quarter-hour. Transformation from mFRR requested (MW) to mFRR energy requested (MWh) for one quarter-hour is described in section 10.2.2.

The mFRR energy to be supplied for a quarter-hour, is calculated as follows:

$$mFRR \text{ energy to be supplied}_{QH} = \sum_{i=1}^{mFRR \text{ Energy Bids activated during the QH}} (\text{ramping factor}_i \times mFRR \text{ energy requested}_i)$$

#### Determination of the ramping factor

The ramping factor for each quarter-hour of an activated mFRR Energy Bid is equal to:

- 80% in case the concerned quarter-hour includes one upward and one downward ramping; or
- 90% in case the concerned quarter-hour only includes one upward or one downward ramping.

This rule does not apply in the following two cases:

- If consecutive activations<sup>42</sup> are requested for upward mFRR Energy Bids part of the same bid group (cf. section 7.1.2.7.3):

	The mFRR Requested for the <b>next quarter-hour<sup>43</sup></b> is <b>higher than or equal to</b> the mFRR Requested of the concerned quarter-hour	The mFRR Requested for the <b>next quarter-hour<sup>43</sup></b> is <b>lower than</b> the mFRR Requested of the concerned quarter-hour
The mFRR Requested for the <b>previous quarter-hour<sup>44</sup></b> is <b>higher than or equal to</b> the mFRR Requested of the concerned quarter-hour	100%	90%
The mFRR Requested for the <b>previous quarter-hour<sup>44</sup></b> is <b>lower than</b> the mFRR Requested of the concerned quarter-hour	90%	80%

Table 13: Ramping factors in case of upward activations requested for bids part of the same bid group

- If consecutive activations<sup>42</sup> are requested for downward mFRR Energy Bids part of the same bid group (cf. section 7.1.2.7.3):

	The mFRR Requested for the <b>next quarter-hour<sup>43</sup></b> is <b>lower than or equal to</b> the mFRR Requested of the concerned quarter-hour	The mFRR Requested for the <b>next quarter-hour<sup>43</sup></b> is <b>higher than</b> the mFRR Requested of the concerned quarter-hour
The mFRR Requested for the <b>previous quarter-hour<sup>44</sup></b> is <b>lower than or equal to</b> the mFRR Requested of the concerned quarter-hour	100%	90%
The mFRR Requested for the <b>previous quarter-hour<sup>44</sup></b> is <b>higher than</b> the mFRR Requested of the concerned quarter-hour	90%	80%

Table 14: Ramping factors in case of downward activations requested for bids part of the same bid group

**Example 1 with the following assumptions:**

- Three mFRR Energy Bids (i.e., mFRR Energy Bid A, B & C) are submitted part of a same bid group;
- mFRR Energy Bid A is submitted for QH2, mFRR Energy Bid B for QH3 and mFRR Energy Bid C for QH4;
- The three mFRR Energy Bids receive a Scheduled Activation request;
- The mFRR Requested is equal to 100MW for mFRR Energy Bid A and 50MW for mFRR Energy Bid B and C.

<sup>42</sup> "Consecutive activations" also includes the cases where a Scheduled Activation (or a Direct Activation) is requested two quarter-hours after a Direct Activation.

<sup>43</sup> In case the concerned quarter-hour is the first quarter-hour of a Direct Activation, the next quarter-hour will always have an mFRR Requested equal to the mFRR Requested of the concerned quarter-hour.

<sup>44</sup> In case the concerned quarter-hour is the second quarter-hour of a Direct Activation, the previous quarter-hour will always have an mFRR Requested equal to the mFRR Requested of the concerned quarter-hour.



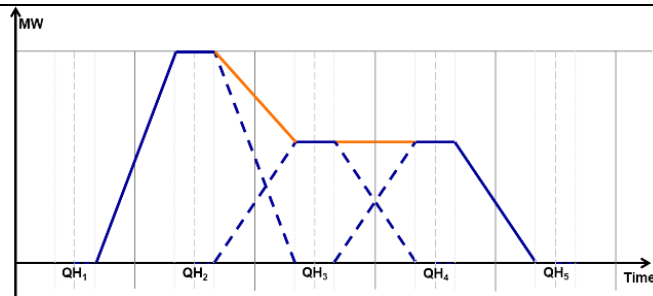

Figure 37: Example of consecutive activation of mFRR Energy Bids part of a same bid group

The ramping factors are as shown in the table below:

	mFRR Requested [MW]	mFRR energy requested [MWh]	Ramping factor
QH1	0	0	-
QH2	100	$100 \times \frac{1}{4} = 25$	80%
QH3	50	$50 \times \frac{1}{4} = 12,5$	100%
QH4	50	$50 \times \frac{1}{4} = 12,5$	90%
QH5	0	0	-

Table 15: Example 1 of ramping factors determination

**Example 2 with the following assumptions:**

- Two mFRR Energy Bids (i.e., mFRR Energy Bid D & E) are submitted part of a same bid group;
- mFRR Energy Bid D is submitted for QH2 and mFRR Energy Bid E is submitted for QH3;
- mFRR Energy Bid D receives SA request and mFRR Energy Bid E receives DA request 2.5 minutes before the start of QH3;
- The mFRR Requested is equal to 50MW mFRR Energy Bid D and 100MW for mFRR Energy Bid E.

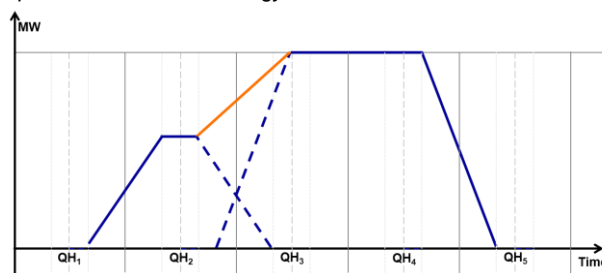

Figure 38: Example of consecutive activation of mFRR Energy Bids part of a same bid group

The ramping factors are as shown in the table below:

	mFRR Requested [MW]	mFRR energy requested [MWh]	Ramping factor
QH1	0	0	-
QH2	50	$50 \times \frac{1}{4} = 12,5$	90%
QH3	100	$100 \times \frac{1}{4} \times \frac{15-5}{15} = 16,67$	90%
QH4	100	$100 \times \frac{1}{4} = 25$	90%
QH5	0	0	-

Table 16: Example 2 of ramping factors determination

## Determination of the mFRR Energy Missing

For each BSP, ELIA will perform an activation control of the total mFRR energy to be supplied per quarter-hour, by verifying whether the BSP has supplied sufficient mFRR energy in comparison with the total netted energy to be supplied based on all upward and downward mFRR activation requested for the concerned quarter-hour.

ELIA determines therefore the mFRR Energy Missing (in MWh) as follows:

- For a netted upward activation (i.e., *mFRR energy to be supplied<sub>QH</sub>* positive):  

$$mFRR \text{ Energy Missing}_{QH} = mFRR \text{ energy to be supplied}_{QH} - mFRR \text{ energy supplied}_{QH}$$
- For a netted downward activation (i.e., *mFRR energy to be supplied<sub>QH</sub>* negative):  

$$mFRR \text{ Energy Missing}_{QH} = -(mFRR \text{ energy to be supplied}_{QH} - mFRR \text{ energy supplied}_{QH})$$

The mFRR energy to be supplied is based on the mFRR Requested (as defined at the beginning of this section) and the mFRR energy supplied per quarter-hour is calculated as follows:

- For a netted upward activation (i.e., *mFRR energy to be supplied<sub>QH</sub>* positive):

$$mFRR \text{ energy supplied}_{QH} = \min \left( \max \left\{ 0; \sum_{DP=1}^{\text{Participating Delivery Points}} mFRR \text{ energy supplied}_{DP} \right\}; mFRR \text{ energy to be supplied}_{QH} \right)$$

- For a netted downward activation (*mFRR energy to be supplied<sub>QH</sub>* negative):

$$mFRR \text{ energy supplied}_{QH} = \max \left( \min \left\{ 0; \sum_{DP=1}^{\text{Participating Delivery Points}} mFRR \text{ energy supplied}_{DP} \right\}; mFRR \text{ energy to be supplied}_{QH} \right)$$

the mFRR energy supplied per Delivery Point is based on the metering and the Baseline of the concerned Delivery Point. ELIA will also cap this value to the  $DP_{mFRR,max,up}$  (resp.  $DP_{mFRR,max,down}$ ) in case the Delivery Point is participating to an upward (resp. downward) activation.

In the calculation of the mFRR energy supplied per quarter-hour, ELIA will only take into account the Delivery Points with a contribution of more than 0 MW in the 2<sup>nd</sup> acknowledgement message sent by the BSP in response to the activation request.

An **mFRR Energy Missing of more than 0MWh indicates an under-delivery** and therefore a **non-compliant** activation. In case of net under-delivery, the BSP will be subject to the penalty explained in section 12.3.

The activation control explained in this section, concerns the verification of delivery following the activation of mFRR Energy Bids for balancing purpose. Bids activated as part of an availability test are controlled separately, as explained in section 11.1.2. The activation control of mFRR Energy Bids activated locally for congestion management is explained in section 13.2.

**Example**

Table 17 shows one downward mFRR Energy Bid submitted for QH<sub>-1</sub> and activated in DA.

Bid	Capacity type	Delivery point	mFRR Power Requested (MW)
0	Non-contracted	Z	- 100

Table 17. Example of ongoing downward DA requested for QH<sub>-1</sub>

Table 18 shows a list of upward mFRR Energy Bids submitted for QH<sub>0</sub>.

Due to an mFRR demand for SA, bids 1, 3, 5 and (partially) 6 are selected for a SA.

Bid	Capacity type	Delivery point	Bid volume (MW)		Bid	Capacity type	Delivery point	mFRR Power Requested (MW)
1	Contracted	A, B	40	Selected	1	Contracted	A, B	40
3	Contracted	C	50		3	Contracted	C	50
5	Non-contracted	D	50		5	Non-contracted	D	50
6	Contracted	E	30		6	Contracted	E	20 (partial)
7	Non-contracted	D	50					
8	Non-contracted	F	50					

Table 18. Example of mFRR Energy Bids of QH<sub>0</sub> selected for a SA

Table 19 shows the calculations for the **activation control**: Based on the list of the participating DPs from the 2<sup>nd</sup> acknowledgement message, ELIA calculates the mFRR energy supplied by each DP and in total for QH<sub>0</sub>. The example shows that, on bid level, the energy supplied was either lower or higher than the mFRR energy be supplied, however, in total the BSP has a small over-delivery of 0,5MWh.

	Bid	Capacity type	DP	mFRR Power Requested (MW)	mFRR Energy Requested (MWh)	mFRR Energy To Be Supplied (MWh)		mFRR Energy Supplied per DP (MWh)
Ongoing DA from <u>qh(t-1)</u>	0	Non-contracted	Z	- 100	- 25	- 22,5	Z	Z: - 20 MWh
SA <u>qh(t0)</u>	1	Contracted	A, B	40	10	8	A	A: 5 MWh
	3	Contracted	C	50	12,5	10	C	C: 0 MWh
	5	Non-contracted	D	50	12,5	10	D	D: 20 MWh
	6	Contracted	E	20 (partial)	5	4	E	E: 5 MWh

2<sup>nd</sup> acknowledgement message: participating DP

Total net mFRR Energy To Be Supplied = + 9,5 MWh

Total mFRR Energy Supplied = + 10 MWh

Table 19. Example of activation control for QH<sub>0</sub>

### 11.2.2. Activation control for Combo mFRR-Redispatching on the same DP

As described in section 4.2.2, the situation may occur that during a quarter-hour with an mFRR activation of a participating DP, there is also an activation in the same direction requested for redispatching. This is particularly the case for DP<sub>SU</sub> with non-contracted, available active power, as in line with the article 248 of the Federal Grid Code, the available power has to be put at the disposal of ELIA in both a balancing energy bid and a redispatching energy bid.

In this case, ELIA applies the activation control principles as explained in section 11.2.1 but considers the impact of the combo-activation on the settlement of the products (i.e., allocation of supplied energy between mFRR and RD). As location matters for redispatching, ELIA will first allocate the energy supplied on a DP to redispatching. The energy delivered beyond the sum of the scheduled energy and the energy delivered for the RD activation will be allocated to mFRR. The examples below show the concrete impact on the mFRR settlement.

**Example 1: One common DP used in an activation for RD and mFRR**

On DP1:

- 20MW upward is offered in a contracted mFRR Energy Bid;
- 40MW upward is offered in both a non-contracted mFRR Energy Bid and RD Energy Bid.

Assume that ELIA first requests the activation of the full volume of the RD Energy Bid. Consequently, the BSP has to update its bids and declare the mFRR Energy Bid A as unavailable for an mFRR activation. Then ELIA also activates the contracted mFRR Energy Bid of 20MW for a SA.

mFRR Energy Bids for Qh <sub>0</sub>				RD Energy Bids for Qh <sub>0</sub>			
Bid #	Bid Volume	DP #	Capacity type	Bid #	Bid Volume	DP #	Capacity type
A	40 MW	DP1	Non-contracted	C	40 MW	DP1	N/A
B	20 MW	DP1	Contracted				

Table 20: Use case for the activation of a same DP for RD and for mFRR

$RD \text{ Requested} = 40 \text{ MW} \rightarrow RD \text{ energy requested} = \frac{1}{4} \times 40 = 10 \text{ MWh} \rightarrow RD \text{ energy to be supplied} = 90\% \times 10 = 8 \text{ MWh}$

$mFRR \text{ Requested} = 20 \text{ MW} \rightarrow mFRR \text{ energy requested} = \frac{1}{4} \times 20 = 5 \text{ MWh} \rightarrow mFRR \text{ energy to be supplied} = 80\% \times 5 = 4 \text{ MWh}$

→ The total energy to be supplied by the BSP during the concerned quarter-hour = 12 MWh

Based on the metering, ELIA determines that **the energy that was supplied on DP1 was 10MWh**. There is therefore a total shortage of 2MWh and the question is how this is allocated across the products:

- ELIA first allocates the supplied energy to redispatching by taking the minimum of the energy that was supplied on the DP and the energy that was to be supplied for redispatching: **Allocation to RD = min (8 MWh ; 10 MWh) = 8 MWh**
- Then ELIA allocates the remaining supplied energy to mFRR, by removing the “allocation to RD” to the total energy supplied by the BSP: **Allocation to mFRR = 10 MWh – 8 MWh = 2 MWh**

→There is under-delivery of 2MWh for mFRR

**Example 2: Partially common DP belonging to the same Technical Facility used in an activation for RD and mFRR**

This second example shows a case where some DPs of a same Technical Facility are included in both RD Energy Bids and mFRR Energy Bids. A typical use case would concern a CCGT with a volume offered on the ST+ GT1 (DP2 and DP3) and on the ST+GT2 (DP2 and DP4).

Assume that ELIA first requests the activation of the RD Energy Bid F of 50MW on DP2 and DP3 (location matters). Consequently, the BSP has to update its bids and declare the mFRR Energy Bid D as unavailable for an mFRR activation. Then ELIA also activates the Bid mFRR Energy Bid E of 50MW on DP2 and DP4 for a SA.

mFRR Energy Bids for Qh <sub>0</sub>				RD Energy Bids for Qh <sub>0</sub>			
Bid #	Bid Volume	DP #	Capacity type	Bid #	Bid Volume	DP #	Capacity type
D	50 MW	DP2	Non-contracted	F	50 MW	DP2	N/A
		DP3				DP3	
E	50 MW	DP2	Non-Contracted	G	50 MW	DP2	N/A
		DP4				DP4	

Table 21: Use case for the activation of a same DP for RD and for mFRR

$RD \text{ Requested} = 50 \text{ MW} \rightarrow RD \text{ energy requested} = \frac{1}{4} \times 50 = 12.5 \text{ MWh} \rightarrow RD \text{ energy to be supplied} = 90\% \times 12.5 = 11.25 \text{ MWh}$

$mFRR \text{ Requested} = 50 \text{ MW} \rightarrow mFRR \text{ energy requested} = \frac{1}{4} \times 50 = 12.5 \text{ MWh} \rightarrow mFRR \text{ energy to be supplied} = 80\% \times 12.5 = 10 \text{ MWh}$

→ The total energy to be supplied by the BSP during the concerned quarter-hour = 21.25 MWh

Based on the metering ELIA determines that the **energy that was supplied on different DP** is as follows:

- Energy supplied on DP2 (ST) = 6 MWh
- Energy supplied on DP3 (GT1) = 2 MWh
- Energy supplied on DP4 (GT2) = 4 MWh

There is therefore a total shortage of 9.25 MWh and the question is how this is allocated across the products:

- ELIA first allocates the supplied energy to redispatching by taking the minimum of the energy that was supplied on DP2 & DP3 and the energy that was to be supplied for redispatching: **Allocation to RD** =  $\min (11.25 \text{ MWh} ; 6+2 \text{ MWh}) = 8 \text{ MWh}$

→There is under-delivery of 3.25 MWh for redispatching.

- Then ELIA allocates the remaining supplied energy to mFRR by taking the minimum energy value of non-allocated energy on the whole of the Technical Facility and the energy supplied on only the DP that participated in the mFRR activation: **Allocation to mFRR** =  $\min (6+2+4 \text{ MWh} - 8 \text{ MWh} ; 6 + 4 \text{ MWh}) = 4 \text{ MWh}$

→There is under-delivery of 6MWh for mFRR

## 12. Penalties

### 12.1. Penalties for MW (not) Made Available

This section reflects the design in the current BSP Contract mFRR. There is no change foreseen in the future design related to penalties related to mFRR Made Available.

ELIA strongly values being able to rely on the mFRR Balancing Capacity bought by BSPs as this is a result of the dimensioning of Balancing Services and an important part in operating the grid securely. Therefore, in case a BSP does not submit sufficient mFRR energy compared to its mFRR Obligation for the concerned quarter-hour (as explained in section 11.1.1), the BSP is subject to a penalty. However, ELIA also understands that unexpected problems may occur that are not to be interpreted as a sign of risky portfolio management from the BSP. Consequently, the penalty makes the distinction between one-time events and repeated behavior:

- The penalty is calculated for each **CCTU**.
- The penalized volume (expressed in MW/h) reflects the sum of the “MW not made available” during all quarter-hours of the concerned CCTU.
- The financial value of the penalty (“**CP<sub>WA</sub>**”) is based on the concerned BSP’s average<sup>45</sup> balancing capacity price for Awarded mFRR during the last 30 days.
- The penalty increases with an ‘aggravating factor’ (“**#CCTU<sub>non-compliant</sub>**”). The factor takes into consideration the number of CCTU with “MW not made available” on day D and during the previous 29 days compared to the overall number of CCTU with mFRR Capacity for the concerns mFRR Capacity Product awarded to the concerned BSP during the same period. This factor therefore allows that the penalty makes the distinction between BSP’s with few problems to respect their mFRR Obligations and BSP’s with structural problems.

$$P_{mFRR \text{ Made Available}}(\text{Month } M) = \sum_{\text{All CCTU of Month } M} P_{mFRR \text{ Made Available}}(\text{CCTU})$$

$$P_{mFRR \text{ Made Available}}(\text{CCTU}) = \#CCTU_{\text{non-compliant}} * MW_{\text{not made available}} * CP_{WA}$$

**Example:**

*Situation day D:*

- On day D-1 for CCTU 1, 2, 3 ELIA awarded a BSP with 100 MW mFRR Capacity (mFRR Standard).

- During CCTU 2 (i.e., 04:00-08:00) the BSP submits mFRR Energy bids = 100MW for all quarter-hours except the first (i.e., quarter-hour 17 of the day) in which the BSP offers 0MW.

=> As the BSP only has one quarter-hour with “MW not made available” of 100MW of the CCTU, the penalized volume equals 25MW/h for the CCTU (i.e., 100 MW / 4).

- During CCTU 3 (i.e., 08:00-12:00) the BSP is not able to submit any mFRR Energy bids: therefore 0 MW for all quarter-hours.

=> As the BSP has “MW not made available” of 100MW for all 16 quarter-hours of the CCTU, the penalized volume equals 400MW/h for the CCTU (i.e., 16 \* 100 MW / 4)

- Therefore, on day D the BSP has 2 CCTU with “MW not made available” for mFRR Standard.

*Situation for the preceding 29 days:*

- The BSP had 25 CCTU with awarded mFRR Capacity for mFRR Standard.

- The weighted average capacity price for that BSP for the mFRR Standard Product = 5 €/MW/h.

<sup>45</sup> The average is a weighted average: the volume of awarded capacity for CCTU(x) serves as a weight for the price of awarded capacity for CCTU(x) in order to determine the average price for the CCTU’s of the entire period.

**- Penalty - CASE 1:** The BSP has no CCTU with “MW not made available” in the 29 days preceding day D:

CCTU 1: no “MW not made available” => no penalty

CCTU 2: Penalty = 2 \* 25 MW/h \* 5 €/MW/h = 250 €

CCTU 3: Penalty = 2 \* 400 MW/h \* 5 €/MW/h = 4000 €

**- Penalty - CASE 2:** The BSP has 10 CCTU with “MW not made available” in the 29 days preceding day D:

CCTU 1: no “MW not made available” => no penalty

CCTU 2: Penalty = 12 \* 25 MW/h \* 5 €/MW/h = 1500 €

CCTU 3: Penalty = 12 \* 400 MW/h \* 5 €/MW/h = 24000 €

## 12.2. Penalties for mFRR Missing MW

This section reflects the design in the current BSP Contract mFRR. There is no change foreseen in the future design related to penalties for mFRR Missing MW.

In case of a failed availability test (as described in section 11.1.2), the energy under-delivery during the test (i.e., the “Missing MW”) are subject to penalties. The financial penalty is determined as follows:

$$P_{mFRR \text{ Missing MW}} = \sum_{\substack{\text{Availability tes(s)} \\ \text{organized in Month M}}} [\alpha \times mFRR \text{ Missing MW} \times CP_{WA} \times \#CCTU] \times hours_{CCTU}$$

With:

- $\alpha$  is a penalty factor that is equal to:
  - 0.75 by default;
  - 1.5 in case the availability test concerns a second consecutive failed availability test.
- *mFRR Missing MW* is the mFRR Missing MW of the concerned availability test defined in section 11.1.2.
- $CP_{WA}$  is the weighted average<sup>46</sup> of capacity prices corresponding to all mFRR Capacity Bids awarded to the BSP for the period comprised between Day D-29 until Day D (i.e., 30 Days), where Day D is the date of performance of the concerned availability test. The weight is the mFRR Awarded for the concerned mFRR Capacity Bid.
- $\#CCTU$  is the number of CCTU for which at least one mFRR Capacity Bid has been awarded to the BSP for the period comprised between Day D-29 until Day D (i.e., 30 Days), where Day D is the date of performance of the concerned availability test.
- $hours_{CCTU}$  is number of hours in a CCTU (i.e., 4).

As explained in section 11.1.2, ELIA reduces a BSP’s prequalified volume in case of two failed consecutive availability tests.

<sup>46</sup> The average is a weighted average: the volume of awarded capacity for CCTU(x) serves as a weight for the price of awarded capacity for CCTU(x) in order to determine the average price for the CCTU’s of the entire period.

### 12.3. Penalties for mFRR Energy Missing

Attention point in comparison to current design: The current design has a penalty for failed activation implying the suspension of Delivery Point, but there is no financial penalty. The suspension of Delivery Points as a penalty is erased. Financial penalties are introduced instead.

As pointed out in section 11.2, an mFRR Energy Missing of more than 0MWh for a quarter-hour QH implies an under-delivery of mFRR energy that will lead to a financial penalty based on the mFRR Energy Missing for this quarter-hour and a penalty price.

The financial penalty is composed of two terms:

$$P_{mFRR \text{ energy missing}}(QH) = \text{penalty}_{base}(QH) + \text{penalty}_{additional}(QH)$$

1. A **base penalty** equal to  $0.25 \times |mFRR \text{ Energy Missing}_{QH} \times \text{penalty price}_{QH}|$
2. An **additional penalty** to discourage any gaming induced by the possibility of arbitration between the activation of the mFRR Energy Bid by the BSP and the potential benefit for the BRP taking a deliberate open position by not delivering the requested energy (as the perimeter of the BRP is anyway corrected with the requested energy). This additional penalty is therefore only applied if the risk of arbitration is present:
  - In case of a netted upward (resp. downward) activation (meaning that the BRP perimeter is corrected in the downward – resp. upward – direction), the additional penalty applies when the Imbalance Price is lower (respectively higher) than the penalty price and is then equal to  $mFRR \text{ Energy Missing}_{QH} \times |Imbalance Price_{QH} - \text{penalty price}_{QH}|$
  - In all other cases, the additional penalty is equal to 0 (zero).

This penalty is very important to avoid that market parties could benefit from a non-compliant mFRR activation leading to a high risk for the security of the system<sup>47</sup>.

The **Imbalance Price** for a quarter-hour is defined in the T&C BRP.

The **mFRR Energy Missing** for a quarter-hour is defined in section 11.2.

For a netted upward (respectively downward) activation over a quarter-hour, the **penalty price** for this quarter-hour (i.e.  $\text{penalty price}_{QH}$ ) is determined as the maximum (respectively minimum) of all applicable prices related to the mFRR Energy Bids with an mFRR Requested for the concerned quarter-hour, i.e. the  $\text{applicable price}_{bid}$  of each concerned mFRR Energy Bid (as defined in section 10.2.1).

**Example 1: Determination of the penalty price per quarter-hour**

	QH <sub>t-1</sub>	QH <sub>t</sub>	QH <sub>t+1</sub>
mFRR Energy Bid 1 – DOWN	SA $MP_{SA,QH_{t-1}} = -10\text{€}/MWh$		
mFRR Energy Bid 2 – UP	DA $MP_{DA,up,QH_t} = 300\text{€}/MWh$		
mFRR Energy Bid 3 – DOWN	DA $MP_{DA,down,QH_t} = -100\text{€}/MWh$		
mFRR Energy Bid 4 – UP		SA $MP_{SA,QH_t} = 400\text{€}/MWh$	
mFRR Energy Bid 5 – UP		DA $MP_{DA,up,QH_t} = 420\text{€}/MWh$	
mFRR Energy Bid 6 – UP			SA $MP_{SA,QH_{t+1}} = 150\text{€}/MWh$

Figure 39: Example of Marginal prices for multiple activations

<sup>47</sup> Note that this approach shall be re-evaluated if the mechanism for the BRP perimeter correction evolves in the future.



	Remuneration per mFRR Energy Bid and per quarter-hour		
	QH <sub>-1</sub>	QH <sub>0</sub>	QH <sub>+1</sub>
mFRR Energy Bid 1	-10€/MWh	N/A	N/A
mFRR Energy Bid 2	$\max(-10 ; 300)$ = 300€/MWh	$\max(400 ; 300)$ = 400€/MWh	N/A
mFRR Energy Bid 3	$\min(-10 ; -100)$ = -100€/MWh	$\min(400 ; -100)$ = -100€/MWh	N/A
mFRR Energy Bid 4	N/A	400€/MWh	N/A
mFRR Energy Bid 5	N/A	$\max(400 ; 420)$ = 420€/MWh	$\max(150 ; 420)$ = 420€/MWh
mFRR Energy Bid 6	N/A	N/A	150€/MWh

Table 22: Example of applicable prices determination

	Netted activation	Activated mFRR Energy Bids	Penalty price
QH <sub>-1</sub>	Downward	mFRR Energy Bids 1, 2 and 3	$\min(-10 ; 300 ; -100) = -100€/MWh$
QH <sub>0</sub>	Upward	mFRR Energy Bids 2, 3, 4 and 5	$\max(400 ; -100 ; 400 ; 420) = 420€/MWh$
QH <sub>+1</sub>	Upward	mFRR Energy Bids 5 and 6	$\max(420 ; 150) = 420€/MWh$

Table 23: Example of penalty prices determination

**Example 2:**

Assume that for QH(t0), DE and NL are short and activate aFRR. BE is only relatively short and activates only aFRR (no mFRR request to MARI). FR on the other hand is long and requests downward mFRR on MARI, which is partially activated in the ELIA LFC Block:

BSP<sub>A</sub> receives a downward mFRR activation request (mFRR energy requested = -20 MWh) with a clearing price for SA of -200 €/MWh. At the same time, the imbalance price reaches extreme values, as it is set by the aFRR CBMP, equal to 15 k€/MWh for the concerned quarter-hour. BSP<sub>A</sub> does not comply with the activation request, the mFRR Energy Missing is 20 MWh.

The condition ii. for the additional penalty is met (i.e., the BSP/BRP can benefit from a non-compliant activation because of the very favorable imbalance settlement in this case).

The additional penalty serves to counteract this incentive:

Base penalty:  $\text{penalty}_{\text{base},QH} = 0.25 \times 20 \text{ MWh} \times |-200 \text{ €/MWh}| = 1000 \text{ €}$

Additional penalty:  $\text{penalty}_{\text{extra},QH} = 20 \text{ MWh} \times |15000 - (-200)\text{€/MWh}| = 304\,000 \text{ €}$

Total penalty for BSP<sub>A</sub> for QH(t0): 305 000 €

## 12.4. Cap on financial penalties

There is a change in comparison to the current design: due to the fact that two new financial penalties are introduced (one related to the activation control of the total mFRR energy, and the other one related to the activation control of mFRR Energy Bids activated for redispatching), the monthly cap on financial penalties will therefore also take into account the monthly remuneration for both capacity and energy.

The sum of the financial penalties under section 12.1, section 12.2, section 12.3 and section 13.2 is subject to a monthly cap. This penalty cap is equal to the total remuneration (cf. section 10) for the mFRR Service for the concerned Month.

## 13. Local use of mFRR for congestion management purpose

In the current design, contracted mFRR Energy Bids on DP<sub>SU</sub> can already be activated for internal congestion management (i.e., for redispatching purpose). This is kept as a local procedure yet updated given the general design review.

In accordance with EBGL (articles 29 & 30), the methodology on the classification of activation purposes of balancing energy bids (article 3) and the Rules for Coordination and Congestion Management, ELIA can activate mFRR Energy Bids for other purposes than balancing, such as for internal congestion management. This is already today a possibility in the BSP Contract mFRR if no other remedial actions are available in the framework of congestion management. Despite connection to the European mFRR-Platform, the mFRR Energy Bids would be activated locally for congestion management:

- Internal congestion management cannot be covered via the mFRR-Platform considering the requirements for activation on a specific location.
- Needs for countertrading cannot be covered via the mFRR-Platform because of the uncertainty of the resulting impact on a targeted border.

Concretely, it concerns the local activation of contracted mFRR Energy Bids, which is energy that is not available via any other product.

### 13.1. Local selection and activation

ELIA selects mFRR Energy Bids for congestion management based on ELIA risk assessment. Only the contracted mFRR Energy Bids that include Delivery Points located in a specific Electrical Zone which would solve internal congestion, are considered<sup>48</sup>. From the mFRR Technical Go-Live, only contracted mFRR Energy Bids related to DP<sub>SU</sub> can be activated for internal congestion. However, from the go-live of iCAROS phase 2 and according to the framework/design that will be defined by iCAROS at that time, any Delivery Point (DP<sub>SU</sub> and DP<sub>PG</sub>) included in a contracted mFRR Energy Bid will be used for internal congestion.

The group of mFRR Energy Bids concerned by an activation for congestion management as well as the reason for activation (i.e., activation for redispatching purpose) their respective mFRR Requested as well as the start time and the end time of the activation needed for redispatching, are communicated by ELIA to the BSP:

- from the mFRR Balancing GCT of the mFRR Energy Bid activated first; and
- until 7.5 minutes before the start of the quarter-hour for which the first mFRR Energy Bid activated was submitted.

Once the request is sent to BSP, the bid characteristics are frozen for the period of RD activation (i.e., once the BSP is informed of the activation of bids for redispatching, it can no longer update these bids). In parallel, ELIA submits the concerned mFRR Energy Bids with a status “unavailable” to the mFRR-Platform to avoid double activations. In addition, if linking (as per section 7.1.2.7) is used with the bid activated for congestion management, other (linked) bids could be set to unavailable in order to maintain the consistency with the bid activated locally.

---

<sup>48</sup> In case several mFRR Energy Bids that include DPs in the concerned Electrical Zone, are available for activation, a selection will be done based on the prices of the mFRR Energy Bid (lowest bid prices selected first).

In the event that the mFRR Energy Bid of the first quarter-hour of the redispatching activation (i.e., QH<sub>0</sub>) is technically linked to another mFRR Energy Bid of the previous quarter-hour (i.e., QH<sub>-1</sub>), then the activation of the mFRR Energy Bid of QH<sub>-1</sub> implies the unavailability of the mFRR Energy Bid of QH<sub>0</sub>. In order to prevent this unavailability (which would have a negative impact on activation for redispatching), ELIA may change the activation type of the mFRR Energy Bid of QH<sub>-1</sub> to “Scheduled Activation only”.

If the mFRR Energy Bid of the first quarter-hour of the redispatching activation (i.e., QH<sub>0</sub>) is conditionally linked to (an)other mFRR Energy Bid(s) of the previous quarter-hour (i.e., QH<sub>-1</sub> and/or QH<sub>-2</sub>), then the activation of the mFRR Energy Bid(s) of QH<sub>-1</sub> and/or QH<sub>-2</sub> may imply the unavailability of the mFRR Energy Bid of QH<sub>0</sub> (depending on the type of conditional link, as per Table 7 and Table 8). In order to prevent this unavailability (which would have a negative impact on activation for redispatching) and if not already solved by the CRI filtering, ELIA may set the mFRR Energy Bid(s) of QH<sub>-1</sub> and/or QH<sub>-2</sub> to unavailable for activation.

Contrary to activations for balancing purpose, the BSP must deliver the requested power on the Delivery Points included in the original mFRR Energy Bid. The BSP cannot either use the Delivery Points part of the related Supporting mFRR Providing Group to deliver the requested power.

## 13.2. Settlement

### Remuneration

As the mFRR Energy Bids activated for congestion management are locally selected and in a different way than the activations for balancing purposes, the settlement price is determined differently. In case of activation of an mFRR Energy Bid for redispatching, the remuneration for the activation of the concerned mFRR Energy Bid is equal, for each quarter-hour of the activation, to the **multiplication of the mFRR energy requested** (in MWh) for the concerned quarter-hour and a **settlement price** (in €/MWh). The settlement price, for each quarter-hour of activation for redispatching is determined as the maximum between the bid price of the concerned mFRR Energy Bid and the concerned Marginal Price (i.e., the  $MP_{SA,QH}$  as defined in section 10.2.1). The mFRR energy requested is defined in section 10.2.2.

Each mFRR Energy Bid activated in the framework of an activation for redispatching follows the profile of the Scheduled Activation described in section 2.2.

Note that, in line with EBGL article 30(1), the price of the mFRR Energy Bids activated for purpose of congestion management will not set the settlement price for mFRR Energy Bids activated for balancing purposes.

### Activation control and penalties

When ELIA activates a contracted mFRR bid for congestion management, ELIA will also control the energy under-delivery of the concerned bid volume. ELIA will perform the activation control of the contracted mFRR energy to be supplied per quarter-hour, verifying for all the Delivery Points included in the contracted mFRR Energy Bids that were activated for redispatching, whether the BSP has correctly performed the activation.

ELIA considers the activation of an mFRR Energy Bid for redispatching as non-compliant based on the rules of section 11.2. An mFRR Energy Missing of more than 0 MWh for a quarter-hour QH implies an under-delivery of mFRR energy that will lead to a financial penalty determined following the rules of section 12.3.

### 13.3. Impact on the BRP perimeter

The **BRP perimeter** is corrected in the same way as in case of activation for balancing purpose (see section 4.2.1).  
As the activations are locally requested for other purposes than for balancing, **the price of the selected bids does not set the imbalance price.**

## E. LIST OF USEFUL REFERENCES

**Federal Grid Code** of April 22, 2019:

<https://www.ejustice.just.fgov.be/eli/arrete/2019/04/22/2019012009/justel> (French version)

[https://www.ejustice.just.fgov.be/cgi\\_loi/change\\_lg.pl?language=nl&la=N&cn=2019042202&table\\_name=wet](https://www.ejustice.just.fgov.be/cgi_loi/change_lg.pl?language=nl&la=N&cn=2019042202&table_name=wet) (Dutch version)

**Code of Conduct** of October 20, 2022:

<https://www.creg.be/sites/default/files/assets/Publications/Decisions/B2409Annex1.pdf>

ELIA webpage on **Balancing Services** (including documents such as Balancing Rules, LFC BOA, and LFC Means):

<https://www.ELIA.be/en/electricity-market-and-system/system-services/keeping-the-balance/mfrr>

ELIA webpage on the **mFRR Service**:

<https://www.ELIA.be/en/electricity-market-and-system/system-services/keeping-the-balance/mfrr>

ELIA's current **T&C BSP mFRR** entered into force on February 3, 2020:

[https://www.ELIA.be/-/media/project/ELIA/ELIA-site/electricity-market-and-system---document-library/balancing---balancing-services-and-bsp/2020/20200203\\_bsp-contract-mfrr\\_en.pdf](https://www.ELIA.be/-/media/project/ELIA/ELIA-site/electricity-market-and-system---document-library/balancing---balancing-services-and-bsp/2020/20200203_bsp-contract-mfrr_en.pdf)

Guideline on Electricity Balancing (**EBGL**) of November 23, 2017:

[https://www.entsoe.eu/network\\_codes/eb/](https://www.entsoe.eu/network_codes/eb/)

Guideline on Electricity Transmission System Operation (**SOGL**) of August 2, 2017:

[https://www.entsoe.eu/network\\_codes/sys-ops/](https://www.entsoe.eu/network_codes/sys-ops/)

Website of **MARI** (the European implementation project for the creation of the European mFRR-Platform):

[https://www.entsoe.eu/network\\_codes/eb/mari/](https://www.entsoe.eu/network_codes/eb/mari/)

MARI Bid structure and Linking of May 2023:

[MARI – Bid Structure and Linking \(windows.net\)](#)

The Implementation framework for the European platform for the exchange of balancing energy from frequency restoration reserves with manual activation (**mFRR IF**) of September 14, 2022:

[https://eepublicdownloads.entsoe.eu/clean-documents/nc-tasks/220921\\_ACER%20Decision%2014-2022%20on%20the%20Amendment%20of%20the%20mFRRIF%20-%20Annex%20II.pdf](https://eepublicdownloads.entsoe.eu/clean-documents/nc-tasks/220921_ACER%20Decision%2014-2022%20on%20the%20Amendment%20of%20the%20mFRRIF%20-%20Annex%20II.pdf)

Methodology for Pricing Balancing Energy and cross-zonal capacity (**PBE**) used for the exchange of balancing energy or operating the imbalance netting process of February 25, 2022:

[https://eepublicdownloads.entsoe.eu/clean-documents/nc-tasks/220225\\_EB%20Regulation\\_Art.30\\_Amendment\\_ACER%20Decision\\_Annex%20I%20\(1\).pdf](https://eepublicdownloads.entsoe.eu/clean-documents/nc-tasks/220225_EB%20Regulation_Art.30_Amendment_ACER%20Decision_Annex%20I%20(1).pdf)

Methodology for a list of Standard Products for Balancing Capacity (**SPBC**) for frequency restoration reserves and replacement reserves of June 17, 2020:

[https://eepublicdownloads.entsoe.eu/clean-documents/nc-tasks/200617\\_A25\(2\)\\_ACER%20Decision%20SPBC%20Annex%20I.pdf](https://eepublicdownloads.entsoe.eu/clean-documents/nc-tasks/200617_A25(2)_ACER%20Decision%20SPBC%20Annex%20I.pdf)

Methodology for classifying the Activation Purposes of balancing energy bids (**AP**) of July 15, 2020:

[https://eepublicdownloads.entsoe.eu/clean-documents/nc-tasks/200716\\_A29\(3\)\\_ACER%20Decision%2016-2020%20on%20balancing%20APP-%20Annex%20I.pdf](https://eepublicdownloads.entsoe.eu/clean-documents/nc-tasks/200716_A29(3)_ACER%20Decision%2016-2020%20on%20balancing%20APP-%20Annex%20I.pdf)